



# DRV Magic Drill

High Efficiency Indexable Drill



Economical Inserts with 4 Cutting Edges and Excellent Chip Evacuation

2xD to 6xD drilling lineup with 4 chipbreakers for various machining applications

High speed and highly efficient machining with the combination of a CVD outer insert and PVD inner insert

Excellent hole accuracy with a highly rigid design for better chatter resistance

**NEW** Lineup Expansion with New Diameters



Expanded Lineup from Ø0.484"~Ø2.000" and Ø12mm~Ø60mm

# DRV Magic Drill

## High Efficiency Indexable Drill



Economical Inserts with 4 Cutting Edges

Excellent Chip Evacuation with 6D Maximum Deep-Hole Drilling

High Speed and Highly Efficient Machining with the Combination of CVD (Outer Edge) and PVD (Inner Edge) Inserts

### 1 Excellent Drilling Precision with Less Variation in Cutting Diameter

#### Optimal Web Thickness and Low Cutting Force Design Reduces Chattering

Web Thickness Comparison  
(Internal Evaluation)

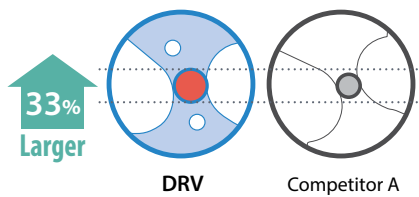

Cutting Diameter Variation Comparison  
(Internal Evaluation)

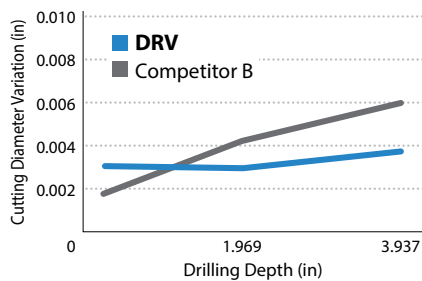

Cutting Conditions : Vc = 490 sfm, f = 0.0024 ipr  
Cutting Dia. Ø0.812" (5D), Wet, Workpiece : 1049

Cutting Force Comparison  
(Internal Evaluation)

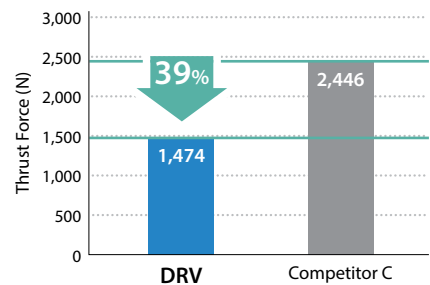

Cutting Conditions : Vc = 660 sfm, f = 0.0047 ipr  
Cutting Dia. Ø0.812" (3D), Wet, Workpiece : 1049

### 2 Unique Insert Design to Control Chip Flow

#### Outer Edge Insert

Unique Insert Pattern to Differentiate between Outside and Inside Inserts



#### Smooth Chip Evacuation with Compact Chips

Chip Shape Comparison of Outer Insert Cutting Edge  
(Internal Evaluation)

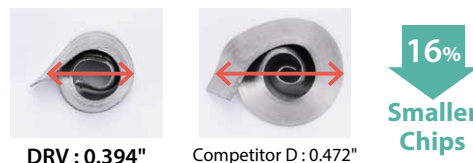

Cutting Conditions : Vc = 490 sfm, f = 0.0024 ipr, Cutting Dia. Ø0.812 (3D), Wet Workpiece : 1049

#### Inner Edge Insert



#### Excellent Chip Evacuation with 6xD Maximum Deep-Hole Drilling

Weight per Unit of Length for Chips Generated by the Inner Insert  
(Internal Evaluation)

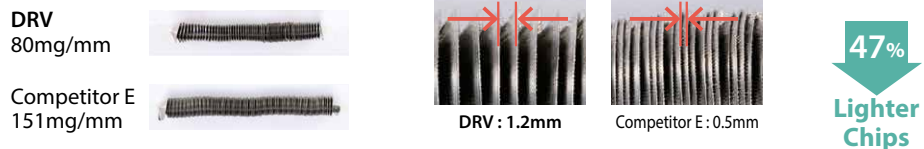

Cutting Conditions : Vc = 820 sfm, f = 0.0031 ipr, Cutting Dia. Ø0.812 (5D), Wet, Workpiece : 304

# 3 New Insert Grades Developed for Drilling

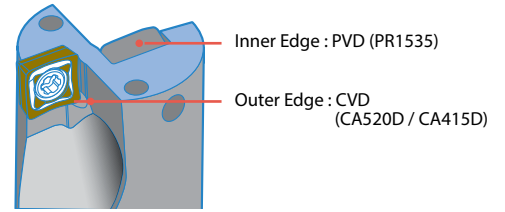

## High Speed and Highly Efficient Machining with the Combination of CVD (Outer Edge) and PVD (Inner Edge) Inserts

Recommended Cutting Conditions (Maximum Values)

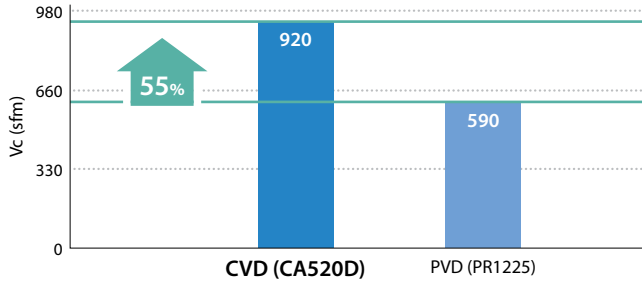

Cutting Dia.  $\varnothing 0.812''$  (3D) Workpiece : 1049

See Page **29** for Insert Grade Selection Guide

Wear Resistance Comparison (Internal Evaluation)

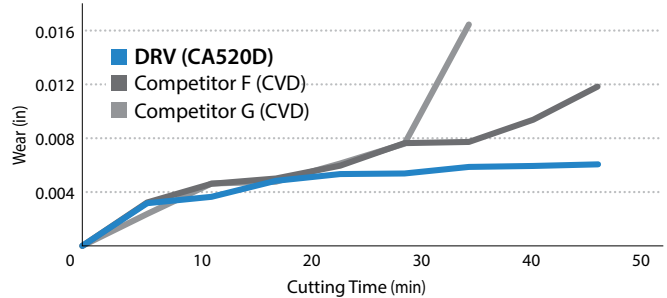

Cutting Conditions : Vc = 660 sfm, f = 0.0047 ipr, Cutting Dia.  $\varnothing 0.812''$  (3D) , Wet Workpiece : 4140H

# 4 Economical 4-Edge Inserts 4 Types of Chipbreakers for Various Machining Applications

## GM Chipbreaker - General Purpose

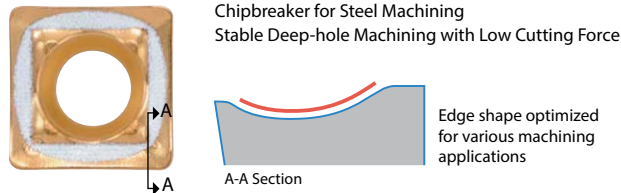

## GH Chipbreaker - Tough Edge

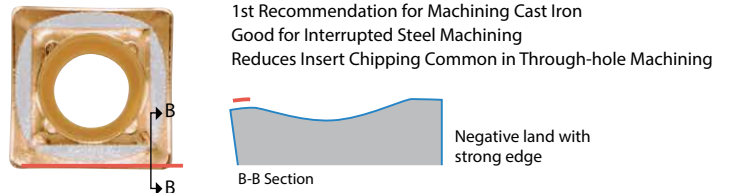

## SM Chipbreaker - For Stainless Steel Machining

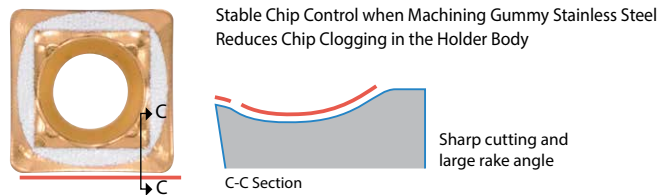

## Chip Control Comparison (Internal Evaluation)

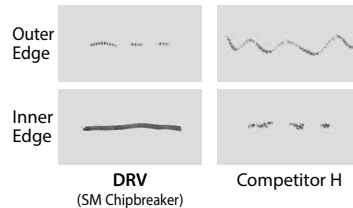

Cutting Conditions : Vc = 330 sfm, f = 0.0039 ipr  
Cutting Dia.  $\varnothing 0.812''$  (3D), Drilling Depth 2.436"  
Wet, Workpiece : 304

## Comparison of Remaining Chips (Internal Evaluation)

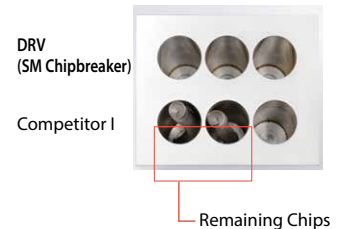

Cutting Conditions : Vc = 490 sfm, f = 0.0031 ipr  
Cutting Dia.  $\varnothing 0.984''$  (5D), Drilling Depth 3.858"  
Wet, Workpiece : 304

## XM Chipbreaker - For Machining Soft Steel and Structural Steel

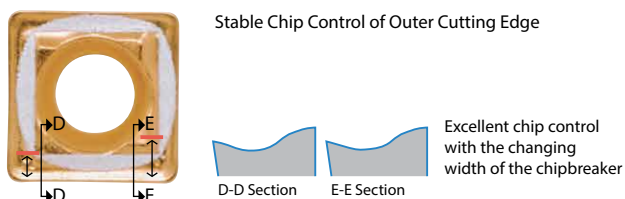

## Chip Control Comparison (Internal Evaluation)

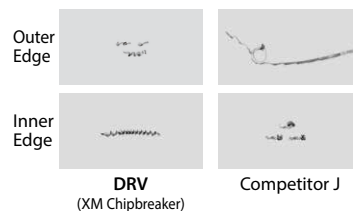

Cutting Conditions : Vc = 660 sfm, f = 0.0047 ipr  
Cutting Dia.  $\varnothing 0.625''$  (3D), Drilling Depth 1.875"  
Wet, Workpiece : A36

Chipbreaker Selection Chart **P6**

# 5 Available for a Wide Range of Machining Applications

Drilling and chamfering is both possible with the DRV chamfering attachment

→ See page 22~23 for more details

Expanded holder lineup:

Ø0.484" ~ Ø2.000" diameters

Ø12mm ~ Ø60mm diameters



Chamfering Attachment



Expanded large holder lineup from Ø0.484" ~ Ø2.000" and Ø40mm ~ Ø60mm diameters  
(Pictured right : S40-DRV550M-3-17)

Wide lineup of toolholder from 2D to 6D

## Drill Diameter Range

### Metric Sizes

**DRV**

Ø12mm~Ø60mm  
2D~6D

### Inch Sizes

**DRV**

Ø0.484"~Ø2.000"  
2D~6D

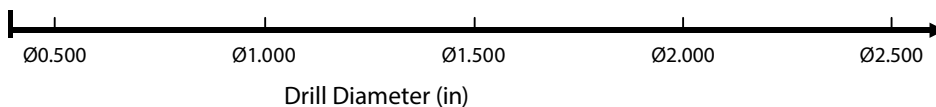

Case Studies

**Housing - Structural Steel**

Vc = 410 sfm (n = 1,660 rpm)  
 f = 0.003 ipr (Vf = 5.236 ipm)  
 Drilling Depth 1.772"  
 Wet (External Coolant)  
 S100-DRV0938-4-07  
 SCMT070310GM-I PR1535  
 SCMT070305GM-E PR1225

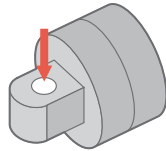

Cutting Time

**DRV**  
 (Ø0.938" 4xD)

**16 sec**

**50%  
 or More**  
 Cutting Time

Competitor K  
 (Ø0.938" 4xD)

**35 sec**

Chattering and recutting chips occurred in low rigidity workpiece of Competitor K. Speed was reduced to Vc = 200 sfm. DRV provided good chip control for stable machining at Vc = 410 sfm.

(User Evaluation)

**Nipple - Stainless Steel**

Vc = 760 sfm (n = 3,330 rpm)  
 f = 0.005 ipr (Vf = 17.047 ipm)  
 Drilling Depth 2.362" (4xD)  
 1.181" (2xD)  
 Wet (Internal Coolant)  
 S100-DRV0875-4-06 (4xD)  
 S100-DRV0875-2-06 (2xD)  
 SCMT060210-GM-I PR1535  
 SCMT060205-GM-E PR1225

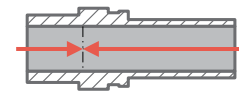

Process 2  
 Drilling Depth 1.181"  
 (2xD)

Process 1  
 Drilling Depth 2.362"  
 (4xD)

Cutting Time

**DRV**  
 (Ø0.875" 4xD/2xD)

**12 sec**

**40%**  
 Cutting Time

Competitor L  
 (Ø0.875" 4xD/2xD)

**20 sec**

Chattering and deflection occurred with Competitor L. DRV showed stable machining and a shorter cutting time even when the cutting conditions were increased by 1.6 times or more.

(User Evaluation)

**Valve Body - Stainless Steel**

Vc = 720 sfm (n = 3,200 rpm)  
 f = 0.002 ipr (Vf = 6.300 ipm)  
 Drilling Depth 1.969"  
 (Blind hole / Through hole)  
 Wet (Internal Coolant)  
 S100-DRV0875-5-06  
 SCMT060205-GM-E PR1225  
 SCMT060210-GM-I PR1535

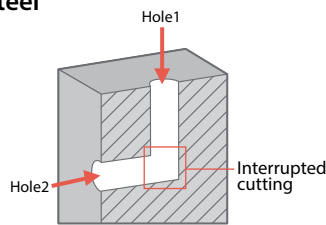

Cutting Time

**DRV**  
 (Ø0.875" 5xD)

**14 sec**

**30%  
 or More**  
 Cutting Time

Competitor M  
 (Ø0.875" 5xD)

**22 sec**

Competitor M : Chattering occurred in the continuous part and then vibration was bigger in the crossed-hole.

DRV : There was no chattering even when increasing cutting speed and there was low vibration in the crossed-hole. The DRV achieved 1.5 times machining efficiency.

(User Evaluation)

**Piston - 4140**

Vc = 820 sfm (n = 3,185 rpm)  
 f = 0.0035 ipr (Vf = 11.417 ipm)  
 Drilling Depth 2.756"  
 (Blind Hole)  
 Wet (Internal Coolant)  
 S100-DRV1000-4-07  
 SCMT070305-GM-E CA520D  
 SCMT070310-GM-I PR1535

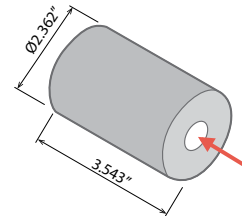

Cutting Time

**DRV**  
 (Ø1.000" 4xD)

**14 sec**

**25%**  
 Cutting Time

Competitor N  
 (Ø1.000" 4xD)

**19 sec**

Competitor N : Loud chattering noise occurred.

DRV : Maintained stable machining. No chattering even at 1.5 times faster cutting speed.

(User Evaluation)

# Chipbreaker Selection Chart

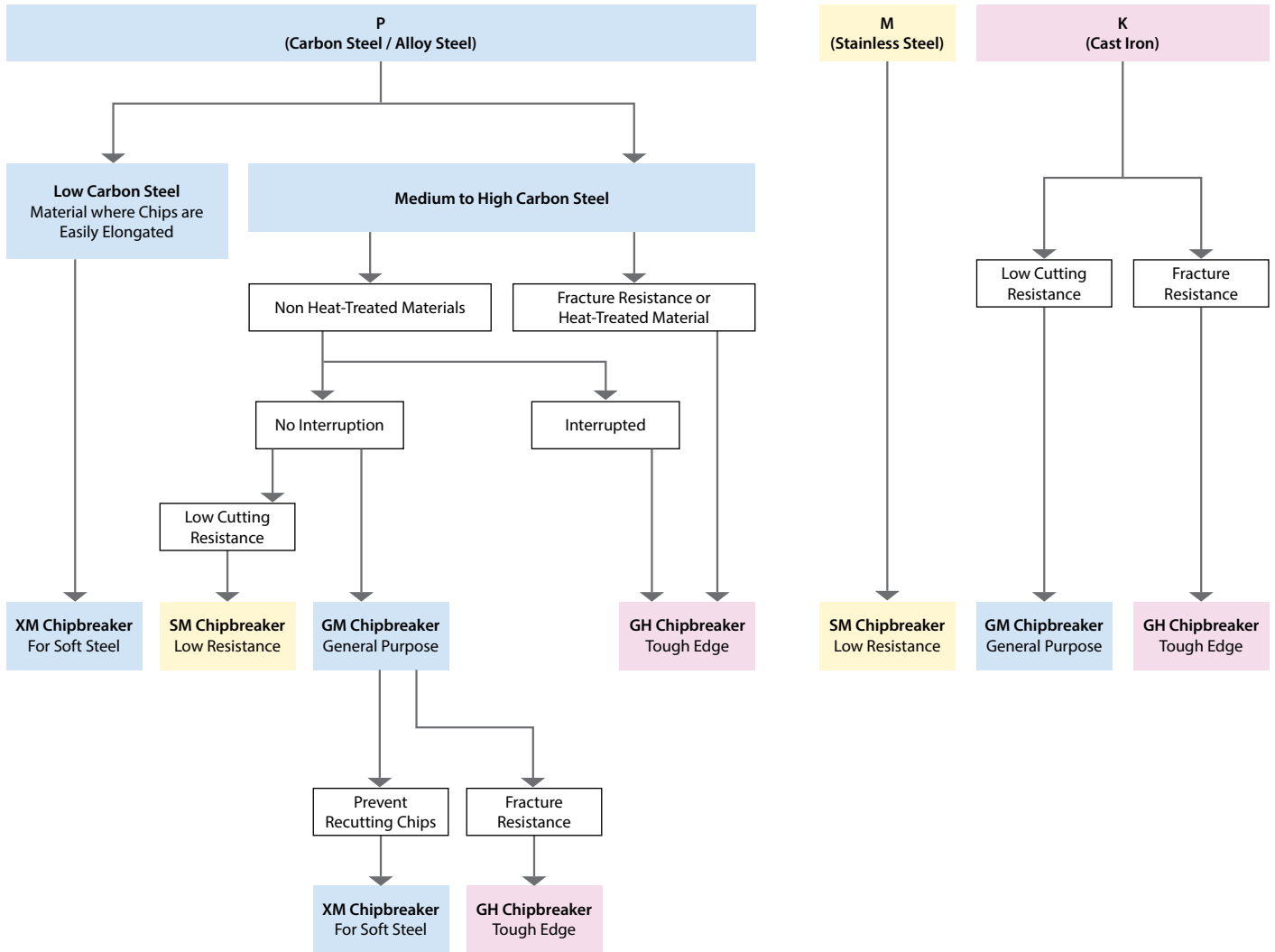

# DRV Toolholders - Inch Sizes

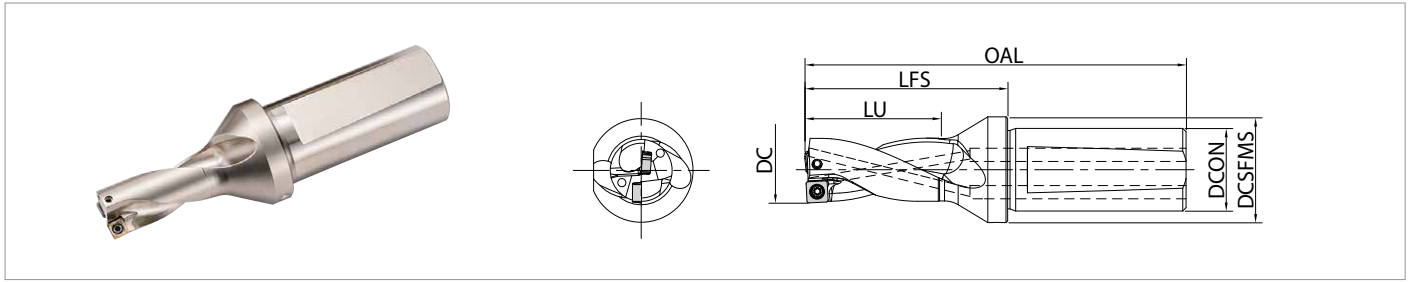

## Toolholder Dimension

2D

(Drilling Depth : 2 × ØDc)

Part Number	Stock	No. of Inserts	Dimension (in)						Max. Radial Offset (in)	Spare Parts		Applicable Insert See <a href="#">Page 20~21</a>
			DC	OAL	LFS	LU	DCON	DCSFMS		Clamp Screw	Wrench	
<b>NEW</b> S075- DRV0484-2-03	●	2	0.484	3.268	1.575	0.969	0.750	1.063	+0.008	SB-2037TRP	FTP-6	Outer Edge LCMT030203-□□-E Inner Edge LCMT030205-□□-I
DRV0500-2-03	●		0.500	3.299	1.606	1.000			+0.006			
<b>NEW</b> DRV0516-2-03	●		0.516	3.331	1.638	1.031			+0.006			
DRV0531-2-03	●		0.531	3.362	1.669	1.063			+0.004			
S075- DRV0562-2-04	●	2	0.563	3.661	1.969	1.125	0.750	1.063	+0.014	SB-2037TRP	FTP-6	Outer Edge SCMT040205-□□-E Inner Edge SCMT040209-□□-I
<b>NEW</b> DRV0578-2-04	●		0.578	3.693	2.000	1.156			+0.014			
S075- DRV0625-2-05	●	2	0.625	3.866	2.173	1.250	0.750	1.063	+0.016	SB-2041TRP	FTP-6	Outer Edge SCMT050205-□□-E Inner Edge SCMT050210-□□-I
DRV0656-2-05	●		0.656	3.929	2.236	1.313			+0.012			
S100- DRV0688-2-05	●	2	0.688	4.425	2.299	1.375	1.000	1.260	+0.010	SB-2555TRP	DTPM-8	Outer Edge SCMT060205-□□-E Inner Edge SCMT060210-□□-I
S100- DRV0750-2-06	●		0.750	4.469	2.343	1.500			+0.024			
DRV0812-2-06	●		0.813	4.594	2.469	1.625			+0.018			
DRV0875-2-06	●		0.875	4.720	2.594	1.750		+0.010				
S100- DRV0938-2-07	●	2	0.938	4.827	2.701	1.875	1.000	1.260	+0.028	SB-3060TRP	DTPM-10	Outer Edge SCMT070305-□□-E Inner Edge SCMT070310-□□-I
DRV0984-2-07	●		0.984	4.917	2.791	1.969			+0.024			
DRV1000-2-07	●		1.000	4.949	2.823	2.000			+0.020			
S125- DRV1062-2-09	●	2	1.063	5.341	3.018	2.125	1.250	1.614	+0.041	SB-3573TRP	DTPM-10	Outer Edge SCMT090405-□□-E Inner Edge SCMT090410-□□-I
DRV1125-2-09	●		1.125	5.467	3.144	2.250			+0.033			
DRV1188-2-09	●		1.188	5.593	3.270	2.375			+0.026			
S150- DRV1250-2-09	●		1.250	6.256	3.539	2.500	1.500	1.929	+0.020			
S150- DRV1312-2-11	●	2	1.313	6.380	3.663	2.625	1.500	1.929	+0.045	SB-4086TRP	DTPM-15	Outer Edge SCMT110406-□□-E Inner Edge SCMT110410-□□-I
DRV1375-2-11	●		1.375	6.506	3.789	2.750			+0.039			
DRV1438-2-11	●		1.438	6.632	3.915	2.875			+0.031			
DRV1500-2-11	●		1.500	6.756	4.039	3.000			+0.022			
S150- DRV1562-2-14	●	2	1.562	7.116	4.400	3.124	1.500	1.929	+0.070	SB-50120TRPH	TTP-20	Outer Edge SCMT140508-□□-E Inner Edge SCMT140510-□□-I
DRV1625-2-14	●		1.625	7.242	4.526	3.250			+0.063			
DRV1688-2-14	●		1.688	7.368	4.652	3.376			+0.056			
DRV1750-2-14	●		1.750	7.492	4.776	3.500		+0.049				
DRV1812-2-14	●		1.812	7.616	4.900	3.624		+0.041				
DRV1875-2-14	●		1.875	7.742	5.026	3.750		+0.034				
DRV1938-2-14	●		1.938	7.868	5.152	3.876		+0.027				
S150- DRV2000-2-17	●		2.000	7.854	5.138	4.000		2.323	+0.079	SB-60130TRP	TTP-20	Outer Edge SCMT170608-□□-E Inner Edge SCMT170610-□□-I

• When offset drilling, reduce feed rate to 0.0031 ipr or less

● : Standard Item

### ■ Estimated Cutting Tolerance (2D)

DC	Estimated Cutting Tolerance (in)
Ø0.484" - Ø2.000"	+0.012 0

The above values are estimates.

These values may change due to machine, workpiece, clamping power, and cutting conditions

Recommended Cutting Conditions [P25](#)

Adjustable Sleeve ASL [P30](#)

# DRV Toolholders - Inch Sizes

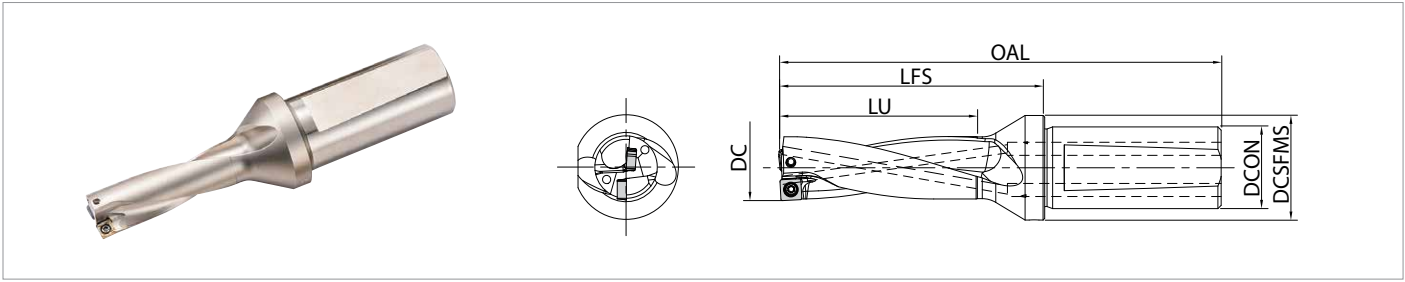

## Toolholder Dimension

3D

(Drilling Depth : 3 × ØDc)

Part Number	Stock	No. of Inserts	Dimension (in)						Max. Radial Offset (in)	Spare Parts		Applicable Insert See <a href="#">Page 20~21</a>
			DC	OAL	LFS	LU	DCON	DCSFMS		Clamp Screw	Wrench	
NEW S075- DRV0484-3-03	●	2	0.484	3.752	2.059	1.453	0.750	1.063	+0.008	SB-2037TRP	FTP-6	Outer Edge LCMT030203-□□-E Inner Edge LCMT030205-□□-I
	●		0.500	3.799	2.106	1.500			+0.006			
	●		0.516	3.847	2.154	1.547			+0.006			
NEW S075- DRV0516-3-03	●	2	0.531	3.894	2.201	1.594	0.750	1.063	+0.004	SB-2037TRP	FTP-6	Outer Edge SCMT040205-□□-E Inner Edge SCMT040209-□□-I
	●		0.563	4.224	2.531	1.688			+0.014			
NEW S075- DRV0578-3-04	●	2	0.578	4.268	2.575	1.734	0.750	1.063	+0.014	SB-2037TRP	FTP-6	Outer Edge SCMT040205-□□-E Inner Edge SCMT040209-□□-I
	●		0.625	4.492	2.799	1.875			+0.016			
S075- DRV0625-3-05	●	2	0.656	4.587	2.894	1.969	0.750	1.063	+0.012	SB-2041TRP	FTP-6	Outer Edge SCMT050205-□□-E Inner Edge SCMT050210-□□-I
	●		0.688	5.114	2.988	2.063			+0.010			
S100- DRV0688-3-05	●	2	0.750	5.220	3.094	2.250	1.000	1.260	+0.024	SB-2555TRP	DTPM-8	Outer Edge SCMT060205-□□-E Inner Edge SCMT060210-□□-I
	●		0.813	5.406	3.280	2.438			+0.018			
	●		0.875	5.594	3.469	2.625			+0.010			
S100- DRV0938-3-07	●	2	0.938	5.764	3.638	2.813	1.000	1.260	+0.028	SB-3060TRP	DTPM-10	Outer Edge SCMT070305-□□-E Inner Edge SCMT070310-□□-I
	●		0.984	5.902	3.776	2.953			+0.024			
	●		1.000	5.949	3.823	3.000			+0.020			
S125- DRV1062-3-09	●	2	1.063	6.402	4.080	3.188	1.250	1.614	+0.041	SB-3573TRP	DTPM-10	Outer Edge SCMT090405-□□-E Inner Edge SCMT090410-□□-I
	●		1.125	6.592	4.269	3.375			+0.033			
	●		1.188	6.781	4.458	3.563			+0.026			
S150- DRV1250-3-09	●	2	1.250	7.508	4.791	3.750	1.500	1.929	+0.020	SB-4086TRP	DTPM-15	Outer Edge SCMT110406-□□-E Inner Edge SCMT110410-□□-I
S150- DRV1312-3-11	●	1.313	7.692	4.976	3.938	1.500	1.929	+0.045				
	●	1.375	7.881	5.165	4.125			+0.039				
S150- DRV1438-3-11	●	2	1.438	8.070	5.354	4.313	1.500	1.929	+0.031	SB-50120TRPH	TTP-20	Outer Edge SCMT140508-□□-E Inner Edge SCMT140510-□□-I
	●		1.500	8.256	5.539	4.500			+0.022			
S150- DRV1562-3-14	●	2	1.562	8.678	5.962	4.686	1.500	1.929	+0.070	SB-50120TRPH	TTP-20	Outer Edge SCMT140508-□□-E Inner Edge SCMT140510-□□-I
	●		1.625	8.867	6.151	4.875			+0.063			
	●		1.688	9.056	6.340	5.064			+0.056			
	●		1.750	9.242	6.526	5.250		+0.049				
	●		1.812	9.428	6.712	5.436		+0.041				
	●		1.875	9.617	6.901	5.625		+0.034				
	●		1.938	9.806	7.090	5.814		+0.027				
S150- DRV2000-3-17	●	2	2.000	9.854	7.138	6.000	2.323	+0.079	SB-60130TRP	TTP-20	Outer Edge SCMT170608-□□-E Inner Edge SCMT170610-□□-I	

• When offset drilling, reduce feed rate to 0.0031 ipr or less

● : Standard Item

### ■ Estimated Cutting Tolerance (3D)

DC	Estimated Cutting Tolerance (in)
Ø0.484" - Ø1.500"	+0.012 0

The above values are estimates.

These values may change due to machine, workpiece, clamping power, and cutting conditions

Recommended Cutting Conditions [P25](#)

Adjustable Sleeve ASL [P30](#)



# DRV Toolholders - Inch Sizes

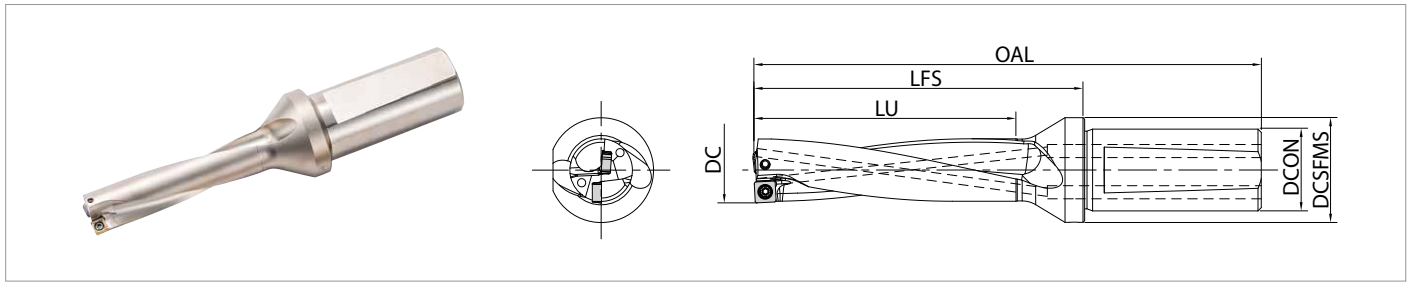

## Toolholder Dimension 4D

(Drilling Depth : 4 × ØDc)

Part Number	Stock	No. of Inserts	Dimension (in)						Max. Radial Offset (in)	Spare Parts		Applicable Insert See <a href="#">Page 20~21</a>
			DC	OAL	LFS	LU	DCON	DCSFMS		Clamp Screw	Wrench	
<b>NEW</b> S075- DRV0484-4-03	●	2	0.484	4.236	2.543	1.938	0.750	1.063	+0.008	SB-2037TRP	FTP-6	Outer Edge LCMT030203-□□-E Inner Edge LCMT030205-□□-I
DRV0500-4-03	●		0.500	4.299	2.606	2.000			+0.006			
DRV0516-4-03	●		0.516	4.362	2.669	2.062			+0.006			
<b>NEW</b> DRV0531-4-03	●		0.531	4.425	2.732	2.125			+0.004			
S075- DRV0562-4-04	●	2	0.563	4.787	3.094	2.250	0.750	1.063	+0.014	SB-2037TRP	FTP-6	Outer Edge SCMT040205-□□-E Inner Edge SCMT040209-□□-I
<b>NEW</b> DRV0578-4-04	●		0.578	4.847	3.154	2.312			+0.014			
S075- DRV0625-4-05	●	2	0.625	5.118	3.425	2.500	0.750	1.063	+0.016	SB-2041TRP	FTP-6	Outer Edge SCMT050205-□□-E Inner Edge SCMT050210-□□-I
DRV0656-4-05	●		0.656	5.240	3.551	2.625			+0.012			
S100- DRV0688-4-05	●	2	0.688	5.803	3.677	2.750	1.000	1.260	+0.010	SB-2555TRP	DTPM-8	Outer Edge SCMT060205-□□-E Inner Edge SCMT060210-□□-I
S100- DRV0750-4-06	●		0.750	5.969	3.843	3.000			+0.024			
DRV0812-4-06	●		0.813	6.217	4.091	3.250			+0.018			
DRV0875-4-06	●		0.875	6.469	4.343	3.500		+0.010				
S100- DRV0938-4-07	●	2	0.938	6.701	4.575	3.750	1.000	1.260	+0.028	SB-3060TRP	DTPM-10	Outer Edge SCMT070305-□□-E Inner Edge SCMT070310-□□-I
DRV0984-4-07	●		0.984	6.886	4.760	3.938			+0.024			
DRV1000-4-07	●		1.000	6.949	4.823	4.000			+0.020			
S125- DRV1062-4-09	●	2	1.063	7.465	5.142	4.250	1.250	1.614	+0.041	SB-3573TRP	DTPM-10	Outer Edge SCMT090405-□□-E Inner Edge SCMT090410-□□-I
DRV1125-4-09	●		1.125	7.717	5.394	4.500			+0.033			
DRV1188-4-09	●		1.188	7.969	5.646	4.750			+0.026			
S150- DRV1250-4-09	●	2	1.250	8.756	6.039	5.000	1.500	1.929	+0.020	SB-4086TRP	DTPM-15	Outer Edge SCMT110406-□□-E Inner Edge SCMT110410-□□-I
S150- DRV1312-4-11	●		1.313	9.004	6.287	5.250			+0.045			
DRV1375-4-11	●		1.375	9.256	6.539	5.500			+0.039			
DRV1438-4-11	●		1.438	9.508	6.791	5.750			+0.031			
DRV1500-4-11	●		1.500	9.756	7.039	6.000		+0.022				
S150- DRV1562-4-14	●	2	1.562	10.240	7.524	6.248	1.500	1.929	+0.070	SB-50120TRPH	TTP-20	Outer Edge SCMT140508-□□-E Inner Edge SCMT140510-□□-I
DRV1625-4-14	●		1.625	10.492	7.776	6.500			+0.063			
DRV1688-4-14	●		1.688	10.744	8.028	6.752			+0.056			
DRV1750-4-14	●		1.750	10.992	8.276	7.000		+0.049				
DRV1812-4-14	●		1.812	11.240	8.524	7.248		2.126	+0.041			
S200- DRV1875-4-14	●	2	1.875	11.492	8.776	7.500	2.000	2.520	+0.034	SB-60130TRP	TTP-20	Outer Edge SCMT170608-□□-E Inner Edge SCMT170610-□□-I
DRV1938-4-14	●		1.938	11.744	9.028	7.752			+0.027			
DRV2000-4-17	●		2.000	11.854	9.138	8.000			+0.079			

• When offset drilling, reduce feed rate to 0.0024 ipr or less

● : Standard Item

### ■ Estimated Cutting Tolerance (4D)

DC	Estimated Cutting Tolerance (in)
Ø0.484" - Ø1.500"	+0.014 0
Ø1.562" - Ø2.000"	+0.016 0

The above values are estimates.

These values may change due to machine, workpiece, clamping power, and cutting conditions

Recommended Cutting Conditions [P26](#)

Adjustable Sleeve ASL [P30](#)

# DRV Toolholders - Inch Sizes

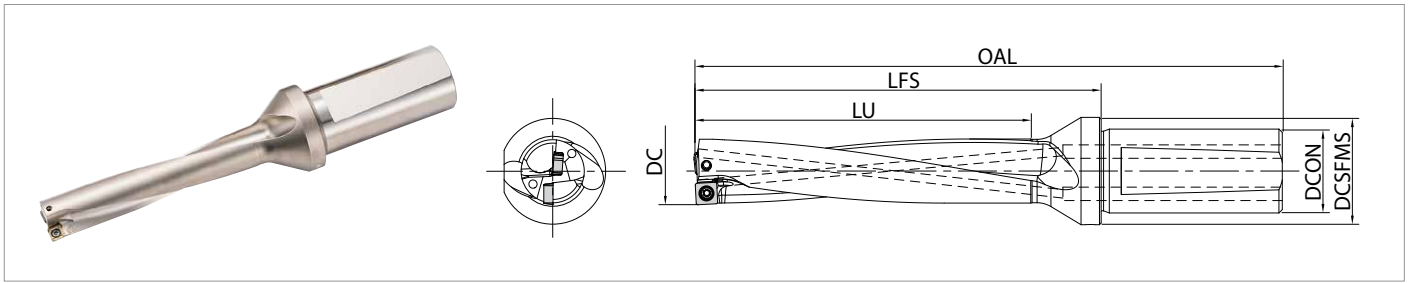

## Toolholder Dimension **5D**

(Drilling Depth : 5 × ØDc)

Part Number	Stock	No. of Inserts	Dimension (in)						Max. Radial Offset (in)	Spare Parts		Applicable Insert See <a href="#">Page 20~21</a>
			DC	OAL	LFS	LU	DCON	DCSFMS		Clamp Screw	Wrench	
<b>NEW</b> S075- DRV0484-5-03	●	2	0.484	4.721	3.028	2.422	0.750	1.063	+0.008	SB-2037TRP	FTP-6	Outer Edge LCMT030203-□□-E Inner Edge LCMT030205-□□-I
DRV0500-5-03	●		0.500	4.799	3.106	2.500			+0.006			
DRV0516-5-03	●		0.516	4.878	3.185	2.578			+0.006			
DRV0531-5-03	●		0.531	4.957	3.264	2.657			+0.004			
S075- DRV0562-5-04	●	2	0.563	5.346	3.654	2.813	0.750	1.063	+0.014	SB-2037TRP	FTP-6	Outer Edge SCMT040205-□□-E Inner Edge SCMT040209-□□-I
DRV0578-5-04	●		0.578	5.425	3.732	2.891			+0.014			
S075- DRV0625-5-05	●	2	0.625	5.744	4.051	3.125	0.750	1.063	+0.016	SB-2041TRP	FTP-6	Outer Edge SCMT050205-□□-E Inner Edge SCMT050210-□□-I
DRV0656-5-05	●		0.656	5.898	4.205	3.281			+0.012			
S100- DRV0688-5-05	●	2	0.688	6.492	4.366	3.438	1.000	1.260	+0.010	SB-2555TRP	DTPM-8	Outer Edge SCMT060205-□□-E Inner Edge SCMT060210-□□-I
S100- DRV0750-5-06	●		0.750	6.720	4.594	3.750			+0.024			
DRV0812-5-06	●		0.813	7.028	4.902	4.063			+0.018			
DRV0875-5-06	●		0.875	7.343	5.217	4.375			+0.010			
S100- DRV0938-5-07	●	2	0.938	7.638	5.512	4.688	1.000	1.260	+0.028	SB-3060TRP	DTPM-10	Outer Edge SCMT070305-□□-E Inner Edge SCMT070310-□□-I
DRV0984-5-07	●		0.984	7.870	5.744	4.922			+0.024			
DRV1000-5-07	●		1.000	7.949	5.823	5.000			+0.020			
S125- DRV1062-5-09	●	2	1.063	8.526	6.204	5.313	1.250	1.614	+0.041	SB-3573TRP	DTPM-10	Outer Edge SCMT090405-□□-E Inner Edge SCMT090410-□□-I
DRV1125-5-09	●		1.125	8.842	6.519	5.625			+0.033			
DRV1188-5-09	●		1.188	9.157	6.834	5.938			+0.026			
S150- DRV1250-5-09	●	2	1.250	10.008	7.291	6.250	1.500	1.929	+0.020	SB-4086TRP	DTPM-15	Outer Edge SCMT110406-□□-E Inner Edge SCMT110410-□□-I
S150- DRV1312-5-11	●		1.313	10.316	7.600	6.563			+0.045			
DRV1375-5-11	●		1.375	10.631	7.915	6.875			+0.039			
DRV1438-5-11	●		1.438	10.946	8.230	7.188			+0.031			
DRV1500-5-11	●		1.500	11.256	8.539	7.500			+0.022			
S150- DRV1562-5-14	●	2	1.562	11.802	9.086	7.810	1.500	1.929	+0.070	SB-50120TRPH	TTP-20	Outer Edge SCMT140508-□□-E Inner Edge SCMT140510-□□-I
DRV1625-5-14	●		1.625	12.117	9.401	8.125			+0.063			
DRV1688-5-14	●		1.688	12.432	9.716	8.440			+0.056			
DRV1750-5-14	●		1.750	12.742	10.026	8.750			+0.049			
DRV1812-5-14	●		1.812	13.052	10.336	9.060			+0.041			
S200- DRV1875-5-14	●		2	1.875	13.367	10.651			9.375			
DRV1938-5-14	●	1.938		13.682	10.966	9.690	+0.027					
DRV2000-5-17	●	2.000		13.854	11.138	10.000	+0.079					

• When offset drilling, reduce feed rate to 0.0020 ipr or less

● : Standard Item

### ■ Estimated Cutting Tolerance (5D)

DC	Estimated Cutting Tolerance (in)
Ø0.484" - Ø1.500"	+0.014 0
Ø1.562" - Ø2.000"	+0.016 0

The above values are estimates.

These values may change due to machine, workpiece, clamping power, and cutting conditions

Recommended Cutting Conditions **P27**

Adjustable Sleeve ASL **P30**

# DRV Toolholders - Inch Sizes

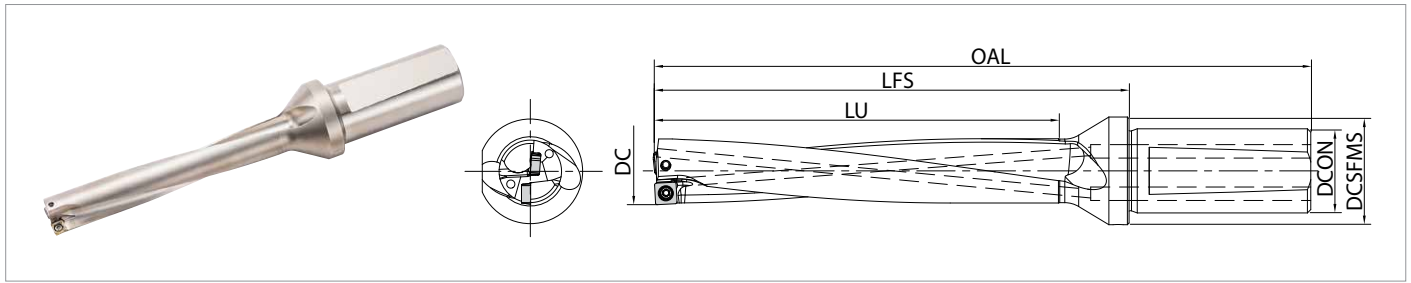

## Toolholder Dimension 6D

(Drilling Depth : 6 × ØDc)

Part Number	Stock	No. of Inserts	Dimension (in)						Max. Radial Offset (in)	Spare Parts		Applicable Insert See <a href="#">Page 20~21</a>
			DC	OAL	LFS	LU	DCON	DCSFMS		Clamp Screw	Wrench	
<b>NEW</b> S075- DRV0484-6-03	●	2	0.484	5.205	3.512	2.906	0.750	1.063	+0.008	SB-2037TRP	FTP-6	Outer Edge LCMT030203-□□-E Inner Edge LCMT030205-□□-I
DRV0500-6-03	●		0.500	5.299	3.606	3.000			+0.006			
DRV0516-6-03	●		0.516	5.394	3.701	3.094			+0.006			
DRV0531-6-03	●		0.531	5.488	3.795	3.188			+0.004			
S075- DRV0562-6-04	●	2	0.563	5.909	4.217	3.375	0.750	1.063	+0.014	SB-2037TRP	FTP-6	Outer Edge SCMT040205-□□-E Inner Edge SCMT040209-□□-I
DRV0578-6-04	●		0.578	6.004	4.311	3.469			+0.014			
S075- DRV0625-6-05	●	2	0.625	6.370	4.677	3.750	0.750	1.063	+0.016	SB-2041TRP	FTP-6	Outer Edge SCMT050205-□□-E Inner Edge SCMT050210-□□-I
DRV0656-6-05	●		0.656	6.555	4.862	3.938			+0.012			
S100- DRV0688-6-05	●	2	0.688	7.181	5.055	4.125	1.000	1.260	+0.010	SB-2555TRP	DTPM-8	Outer Edge SCMT060205-□□-E Inner Edge SCMT060210-□□-I
S100- DRV0750-6-06	●		0.750	7.469	5.343	4.500			+0.024			
DRV0812-6-06	●		0.813	7.843	5.717	4.875			+0.018			
DRV0875-6-06	●		0.875	8.220	6.094	5.250			+0.010			
S100- DRV0938-6-07	●	2	0.938	8.579	6.453	5.625	1.000	1.260	+0.028	SB-3060TRP	DTPM-10	Outer Edge SCMT070305-□□-E Inner Edge SCMT070310-□□-I
DRV0984-6-07	●		0.984	8.854	6.728	5.906			+0.024			
DRV1000-6-07	●		1.000	8.949	6.823	6.000			+0.020			
S125- DRV1062-6-09	●	2	1.063	9.589	7.266	6.375	1.250	1.614	+0.041	SB-3573TRP	DTPM-10	Outer Edge SCMT090405-□□-E Inner Edge SCMT090410-□□-I
DRV1125-6-09	●		1.125	9.967	7.644	6.750			+0.033			
DRV1188-6-09	●		1.188	10.344	8.022	7.125			+0.026			
S150- DRV1250-6-09	●	2	1.250	11.256	8.539	7.500	1.500	1.929	+0.020	SB-4086TRP	DTPM-15	Outer Edge SCMT110406-□□-E Inner Edge SCMT110410-□□-I
S150- DRV1312-6-11	●		1.313	11.628	8.911	7.875			+0.045			
DRV1375-6-11	●		1.375	12.006	9.289	8.250			+0.039			
DRV1438-6-11	●		1.438	12.384	9.667	8.625			+0.031			
DRV1500-6-11	●		1.500	12.756	10.039	9.000			+0.022			
S150- DRV1562-6-14	●	2	1.562	13.364	10.648	9.372	1.500	1.929	+0.070	SB-50120TRPH	TTP-20	Outer Edge SCMT140508-□□-E Inner Edge SCMT140510-□□-I
DRV1625-6-14	●		1.625	13.742	11.026	9.750			+0.063			
DRV1688-6-14	●		1.688	14.120	11.404	10.128			+0.056			
DRV1750-6-14	●		1.750	14.492	11.776	10.500			+0.049			
DRV1812-6-14	●		1.812	14.864	12.148	10.872			+0.041			
S200- DRV1875-6-14	●	2	1.875	15.242	12.526	11.250	2.000	2.520	+0.034	SB-60130TRP	TTP-20	Outer Edge SCMT170608-□□-E Inner Edge SCMT170610-□□-I
DRV1938-6-14	●		1.938	15.620	12.904	11.628			+0.027			
DRV2000-6-17	●		2.000	15.854	13.138	12.000			+0.079			

• When offset drilling, reduce feed rate to 0.0016 ipr or less

● : Standard Item

### ■ Estimated Cutting Tolerance (6D)

DC	Estimated Cutting Tolerance (in)
Ø0.484" - Ø1.500"	+0.018 0
Ø1.562" - Ø2.000"	+0.020 0

The above values are estimates.

These values may change due to machine, workpiece, clamping power, and cutting conditions

Recommended Cutting Conditions [P28](#)

Adjustable Sleeve ASL [P30](#)

# DRV Toolholders - Metric Sizes

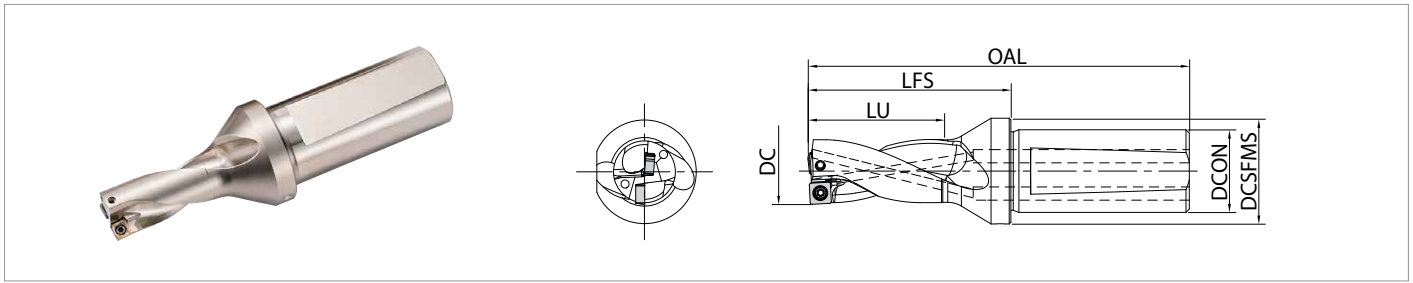

## Toolholder Dimension

2D

(Drilling Depth : 2 × DC)

Part Number	Stock	No. of Inserts	Dimension (mm)						Max. Radial Offset (mm)	Spare Parts		Applicable Insert See <a href="#">Page 20~21</a>
			DC	OAL	LFS	LU	DCON	DCSFMS		Clamp Screw	Wrench	
S20- DRV120M-2-03	●	2	12	82	39	24	20	27	+0.25	SB-2037TRP	FTP-6	Outer Edge LCMT030203-□□-E Inner Edge LCMT030205-□□-I
DRV125M-2-03	●		12.5	83	40	25			+0.20			
DRV130M-2-03	●		13	84	41	26			+0.15			
DRV135M-2-03	●		13.5	85	42	27			+0.10			
S20- DRV140M-2-04	●	2	14	92	49	28	20	27	+0.40	SB-2037TRP	FTP-6	Outer Edge SCMT040205-□□-E Inner Edge SCMT040209-□□-I
DRV145M-2-04	●		14.5	93	50	29			+0.35			
DRV150M-2-04	●		15	94	51	30			+0.30			
DRV155M-2-04	●		15.5	95	52	31			+0.25			
S25- DRV160M-2-05	●	2	16	110	56	32	25	32	+0.40	SB-2041TRP	FTP-6	Outer Edge SCMT050205-□□-E Inner Edge SCMT050210-□□-I
DRV165M-2-05	●		16.5	111	57	33			+0.35			
DRV170M-2-05	●		17	112	58	34			+0.30			
DRV175M-2-05	●		17.5	113	59	35			+0.25			
DRV180M-2-05	●		18	114	60	36			+0.20			
DRV185M-2-05	●		18.5	115	61	37			+0.15			
S25- DRV190M-2-06	●	2	19	113	59	38	25	32	+0.65	SB-2555TRP	DTPM-8	Outer Edge SCMT060205-□□-E Inner Edge SCMT060210-□□-I
DRV195M-2-06	●		19.5	114	60	39			+0.60			
DRV200M-2-06	●		20	115	61	40			+0.55			
DRV205M-2-06	●		20.5	116	62	41			+0.50			
DRV210M-2-06	●		21	117	63	42			+0.45			
DRV215M-2-06	●		21.5	118	64	43			+0.35			
DRV220M-2-06	●		22	119	65	44			+0.30			
S25- DRV225M-2-07	●		2	22.5	120	66			45			
DRV230M-2-07	●	23		121	67	46	+0.80					
DRV235M-2-07	●	23.5		122	68	47	+0.75					
DRV240M-2-07	●	24		123	69	48	+0.70					
DRV245M-2-07	●	24.5		124	70	49	+0.65					
DRV250M-2-07	●	25		125	71	50	+0.60					
DRV255M-2-07	●	25.5		126	72	51	+0.50					
DRV260M-2-07	●	26		127	73	52	+0.45					
S32- DRV270M-2-09	●	2		27	136	77	54	32	41	+1.05	SB-3573TRP	DTPM-10
DRV280M-2-09	●		28	138	79	56	+0.95					
DRV290M-2-09	●		29	140	81	58	+0.85					
DRV300M-2-09	●		30	142	83	60	+0.75					
DRV310M-2-09	●		31	144	85	62	+0.60					
DRV320M-2-09	●		32	146	87	64	+0.50					

• When offset drilling, reduce feed rate to 0.0031 ipr or less

● : Standard Item

# DRV Toolholders - Metric Sizes

## Toolholder Dimension 2D

(Drilling Depth : 2 × DC)

Part Number	Stock	No. of Inserts	Dimension (mm)						Max. Radial Offset (mm)	Spare Parts		Applicable Insert See <a href="#">Page 20~21</a>	
			DC	OAL	LFS	LU	DCON	DCSFMS		Clamp Screw	Wrench		
S40- DRV330M-2-11	●	2	33	161	92	66	40	49	+1.25	SB-4086TRP	DTPM-15	Outer Edge SCMT110406-□□-E Inner Edge SCMT110410-□□-I	
DRV340M-2-11	●		34	163	94	68			+1.15				
DRV350M-2-11	●		35	165	96	70			+1.00				
DRV360M-2-11	●		36	167	98	72			+0.90				
DRV370M-2-11	●		37	169	100	74			+0.80				
DRV380M-2-11	●		38	171	102	76			+0.65				
DRV390M-2-11	●		39	173	104	78			+0.55				
S40- DRV400M-2-14	●	2	40	181	112	80	40	49	+1.75	SB-50120TRPH	TTP-20	Outer Edge SCMT140508-□□-E Inner Edge SCMT140510-□□-I	
DRV410M-2-14	●		41	183	114	82			+1.60				
DRV420M-2-14	●		42	185	116	84			+1.50				
DRV430M-2-14	●		43	187	118	86			+1.40				
DRV440M-2-14	●		44	189	120	88			+1.30				
DRV450M-2-14	●		45	191	122	90		+1.15					
DRV460M-2-14	●		46	193	124	92		54	+1.05				
DRV470M-2-14	●		47	195	126	94			+0.95				
DRV480M-2-14	●		48	197	128	96			+0.80				
DRV490M-2-14	●		49	199	130	98			+0.70				
S40- DRV500M-2-17	●		2	50	198	129			100				40
DRV510M-2-17	●	51		200	131	102	+1.95						
DRV520M-2-17	●	52		202	133	104	+1.85						
DRV530M-2-17	●	53		204	135	106	+1.75						
DRV540M-2-17	●	54		206	137	108	+1.65						
DRV550M-2-17	●	55		208	139	110	+1.50						
DRV560M-2-17	●	56		210	141	112	+1.40						
DRV570M-2-17	●	57		212	143	114	64	+1.30					
DRV580M-2-17	●	58		214	145	116		+1.15					
DRV590M-2-17	●	59		216	147	118		+1.05					
DRV600M-2-17	●	60		218	149	120		+0.95					

• When offset drilling, reduce feed rate to 0.0031 ipr or less

● : Standard Item

### ■ Estimated Cutting Tolerance (2D)

DC	Estimated Cutting Tolerance (mm)
Ø12mm - Ø60mm	+0.30 0

The above values are estimates.

These values may change due to machine, workpiece, clamping power, and cutting conditions

Recommended Cutting Conditions [P25](#)

Adjustable Sleeve SHE [P30](#)

# DRV Toolholders - Metric Sizes

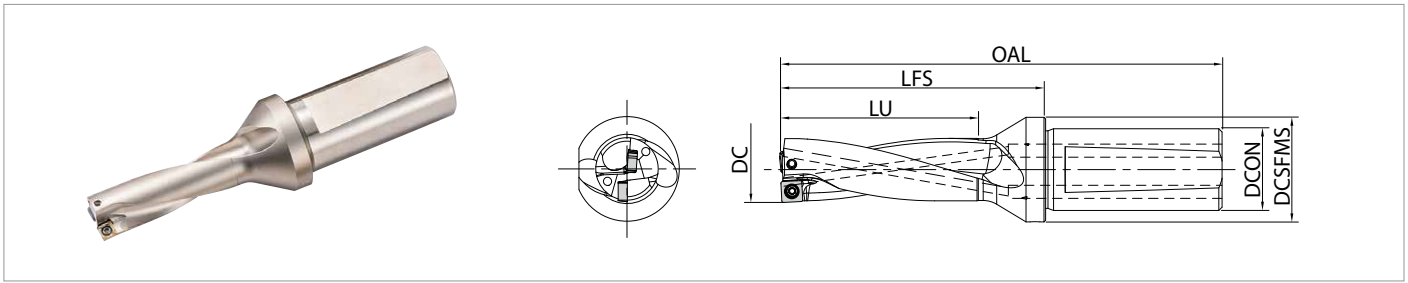

## Toolholder Dimension

3D

(Drilling Depth : 3 × DC)

Part Number	Stock	No. of Inserts	Dimension (mm)						Max. Radial Offset (mm)	Spare Parts		Applicable Insert See <a href="#">Page 20~21</a>	
			DC	OAL	LFS	LU	DCON	DCSFMS		Clamp Screw	Wrench		
S20- DRV120M-3-03	●	2	12	94	51	36	20	27	+0.25	SB-2037TRP	FTP-6	Outer Edge LCMT030203-□□-E Inner Edge LCMT030205-□□-I	
DRV125M-3-03	●		12.5	96	53	37.5							+0.20
DRV130M-3-03	●		13	97	54	39							+0.15
DRV135M-3-03	●		13.5	99	56	40.5							+0.10
S20- DRV140M-3-04	●	2	14	106	63	42	20	27	+0.40	SB-2037TRP	FTP-6	Outer Edge SCMT040205-□□-E Inner Edge SCMT040209-□□-I	
DRV145M-3-04	●		14.5	108	65	43.5							+0.35
DRV150M-3-04	●		15	109	66	45							+0.30
DRV155M-3-04	●		15.5	111	68	46.5							+0.25
S25- DRV160M-3-05	●	2	16	126	72	48	25	32	+0.40	SB-2041TRP	FTP-6	Outer Edge SCMT050205-□□-E Inner Edge SCMT050210-□□-I	
DRV165M-3-05	●		16.5	127	73	49.5							+0.35
DRV170M-3-05	●		17	129	75	51							+0.30
DRV175M-3-05	●		17.5	130	76	52.5							+0.25
DRV180M-3-05	●		18	132	78	54							+0.20
DRV185M-3-05	●		18.5	133	79	55.5							+0.15
S25- DRV190M-3-06	●	2	19	132	78	57	25	32	+0.65	SB-2555TRP	DTPM-8	Outer Edge SCMT060205-□□-E Inner Edge SCMT060210-□□-I	
DRV195M-3-06	●		19.5	134	80	58.5							+0.60
DRV200M-3-06	●		20	135	81	60							+0.55
DRV205M-3-06	●		20.5	137	83	61.5							+0.50
DRV210M-3-06	●		21	138	84	63							+0.45
DRV215M-3-06	●		21.5	140	86	64.5							+0.35
DRV220M-3-06	●		22	141	87	66							+0.30
S25- DRV225M-3-07	●	2	22.5	142	88	67.5	25	32	+0.90	SB-3060TRP	DTPM-10	Outer Edge SCMT070305-□□-E Inner Edge SCMT070310-□□-I	
DRV230M-3-07	●		23	144	90	69							+0.80
DRV235M-3-07	●		23.5	145	91	70.5							+0.75
DRV240M-3-07	●		24	147	93	72							+0.70
DRV245M-3-07	●		24.5	148	94	73.5							+0.65
DRV250M-3-07	●		25	150	96	75							+0.60
DRV255M-3-07	●		25.5	151	97	76.5							+0.50
DRV260M-3-07	●		26	153	99	78							+0.45
S32- DRV265M-3-09	●	2	26.5	161	102	79.5	32	41	+1.15	SB-3573TRP	DTPM-10	Outer Edge SCMT090405-□□-E Inner Edge SCMT090410-□□-I	
DRV270M-3-09	●		27	163	104	81							+1.05
DRV275M-3-09	●		27.5	164	105	82.5							+1.00
DRV280M-3-09	●		28	166	107	84							+0.95
DRV285M-3-09	●		28.5	167	108	85.5							+0.90
DRV290M-3-09	●		29	169	110	87							+0.85
DRV295M-3-09	●		29.5	170	111	88.5							+0.80
DRV300M-3-09	●		30	172	113	90							+0.75
DRV305M-3-09	●		30.5	173	114	91.5							+0.65
DRV310M-3-09	●		31	175	116	93							+0.60
DRV315M-3-09	●		31.5	176	117	94.5							+0.55
DRV320M-3-09	●		32	178	119	96							+0.50

• When offset drilling, reduce feed rate to 0.0031 ipr or less

● : Standard Item

# DRV Toolholders - Metric Sizes

## Toolholder Dimension 3D

(Drilling Depth : 3 × DC)

Part Number	Stock	No. of Inserts	Dimension (mm)						Max. Radial Offset (mm)	Spare Parts		Applicable Insert See <a href="#">Page 20~21</a>	
			DC	OAL	LFS	LU	DCON	DCSFMS		Clamp Screw	Wrench		
S40- DRV330M-3-11	●	2	33	194	125	99	40	49	+1.25	SB-4086TRP	DTPM-15	Outer Edge SCMT110406-□□-E Inner Edge SCMT110410-□□-I	
DRV340M-3-11	●		34	197	128	102			+1.15				
DRV350M-3-11	●		35	200	131	105			+1.00				
DRV360M-3-11	●		36	203	134	108			+0.90				
DRV370M-3-11	●		37	206	137	111			+0.80				
DRV380M-3-11	●		38	209	140	114			+0.65				
DRV390M-3-11	●		39	212	143	117			+0.55				
S40- DRV400M-3-14	●	2	40	221	152	120	40	49	+1.75	SB-50120TRPH	TTP-20	Outer Edge SCMT140508-□□-E Inner Edge SCMT140510-□□-I	
DRV410M-3-14	●		41	224	155	123			+1.60				
DRV420M-3-14	●		42	227	158	126			+1.50				
DRV430M-3-14	●		43	230	161	129			+1.40				
DRV440M-3-14	●		44	233	164	132			+1.30				
DRV450M-3-14	●		45	236	167	135			+1.15				
DRV460M-3-14	●		46	239	170	138		+1.05					
DRV470M-3-14	●		47	242	173	141		54	+0.95				
DRV480M-3-14	●		48	245	176	144			+0.80				
DRV490M-3-14	●		49	248	179	147			+0.70				
S40- DRV500M-3-17	●		2	50	248	179			150				40
DRV510M-3-17	●	51		251	182	153	+1.95						
DRV520M-3-17	●	52		254	185	156	+1.85						
DRV530M-3-17	●	53		257	188	159	+1.75						
DRV540M-3-17	●	54		260	191	162	+1.65						
DRV550M-3-17	●	55		263	194	165	+1.50						
DRV560M-3-17	●	56		266	197	168	+1.40						
DRV570M-3-17	●	57		269	200	171	64	+1.30					
DRV580M-3-17	●	58		272	203	174		+1.15					
DRV590M-3-17	●	59		275	206	177		+1.05					
DRV600M-3-17	●	60		278	209	180		+0.95					

• When offset drilling, reduce feed rate to 0.0031 ipr or less

● : Standard Item

### ■ Estimated Cutting Tolerance (3D)

DC	Estimated Cutting Tolerance (mm)
Ø12mm - Ø60mm	+0.30 0

The above values are estimates.

These values may change due to machine, workpiece, clamping power, and cutting conditions

Recommended Cutting Conditions [P25](#)

Adjustable Sleeve SHE [P30](#)



# DRV Toolholders - Metric Sizes

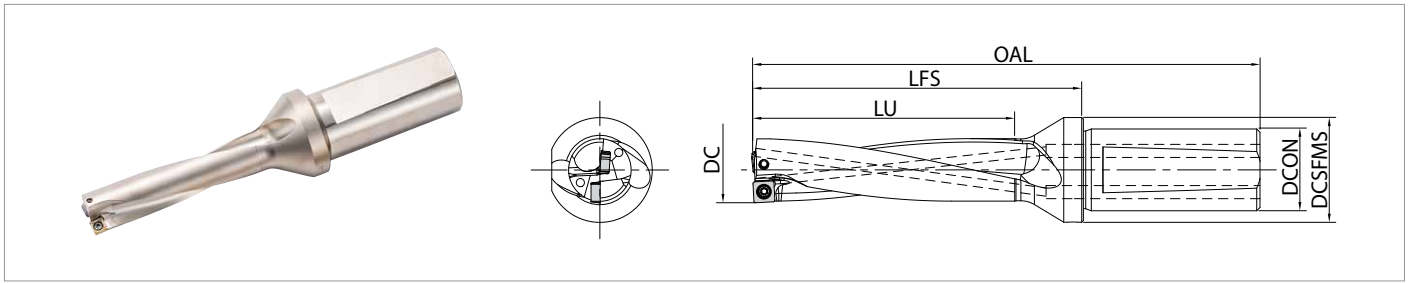

## Toolholder Dimension 4D

(Drilling Depth : 4 × DC)

Part Number	Stock	No. of Inserts	Dimension (mm)						Max. Radial Offset (mm)	Spare Parts		Applicable Insert See <a href="#">Page 20~21</a>
			DC	OAL	LFS	LU	DCON	DCSFMS		Clamp Screw	Wrench	
S20- DRV120M-4-03	●	2	12	106	63	48	20	27	+0.25	SB-2037TRP	FTP-6	Outer Edge LCMT030203-□□-E Inner Edge LCMT030205-□□-I
DRV125M-4-03	●		12.5	108	65	50			+0.20			
DRV130M-4-03	●		13	110	67	52			+0.15			
DRV135M-4-03	●		13.5	112	69	54			+0.10			
S20- DRV140M-4-04	●	2	14	120	77	56	20	27	+0.40	SB-2037TRP	FTP-6	Outer Edge SCMT040205-□□-E Inner Edge SCMT040209-□□-I
DRV145M-4-04	●		14.5	122	79	58			+0.35			
DRV150M-4-04	●		15	124	81	60			+0.30			
DRV155M-4-04	●		15.5	126	83	62			+0.25			
S25- DRV160M-4-05	●	2	16	142	88	64	25	32	+0.40	SB-2041TRP	FTP-6	Outer Edge SCMT050205-□□-E Inner Edge SCMT050210-□□-I
DRV165M-4-05	●		16.5	144	90	66			+0.35			
DRV170M-4-05	●		17	146	92	68			+0.30			
DRV175M-4-05	●		17.5	148	94	70			+0.25			
DRV180M-4-05	●		18	150	96	72			+0.20			
DRV185M-4-05	●		18.5	152	98	74			+0.15			
S25- DRV190M-4-06	●	2	19	151	97	76	25	32	+0.65	SB-2555TRP	DTPM-8	Outer Edge SCMT060205-□□-E Inner Edge SCMT060210-□□-I
DRV195M-4-06	●		19.5	153	99	78			+0.60			
DRV200M-4-06	●		20	155	101	80			+0.55			
DRV205M-4-06	●		20.5	157	103	82			+0.50			
DRV210M-4-06	●		21	159	105	84			+0.45			
DRV215M-4-06	●		21.5	161	107	86			+0.35			
DRV220M-4-06	●		22	163	109	88			+0.30			
S25- DRV225M-4-07	●		2	22.5	165	111			90			
DRV230M-4-07	●	23		167	113	92	+0.80					
DRV235M-4-07	●	23.5		169	115	94	+0.75					
DRV240M-4-07	●	24		171	117	96	+0.70					
DRV245M-4-07	●	24.5		173	119	98	+0.65					
DRV250M-4-07	●	25		175	121	100	+0.60					
DRV255M-4-07	●	25.5		177	123	102	+0.50					
DRV260M-4-07	●	26		179	125	104	+0.45					
S32- DRV270M-4-09	●	2		27	190	131	108	32	41	+1.05	SB-3573TRP	DTPM-10
DRV280M-4-09	●		28	194	135	112	+0.95					
DRV290M-4-09	●		29	198	139	116	+0.85					
DRV300M-4-09	●		30	202	143	120	+0.75					
DRV310M-4-09	●		31	206	147	124	+0.60					
DRV320M-4-09	●		32	210	151	128	+0.50					

• When offset drilling, reduce feed rate to 0.0024 ipr or less

● : Standard Item



# DRV Toolholders - Metric Sizes

## Toolholder Dimension **4D**

(Drilling Depth : 4 × DC)

Part Number	Stock	No. of Inserts	Dimension (mm)						Max. Radial Offset (mm)	Spare Parts		Applicable Insert See <a href="#">Page 20~21</a>
			DC	OAL	LFS	LU	DCON	DCSFMS		Clamp Screw	Wrench	
S40- DRV330M-4-11	●	2	33	227	158	132	40	49	+1.25	SB-4086TRP	DTPM-15	Outer Edge SCMT110406-□□-E Inner Edge SCMT110410-□□-I
DRV340M-4-11	●		34	231	162	136			+1.15			
DRV350M-4-11	●		35	235	166	140			+1.00			
DRV360M-4-11	●		36	239	170	144			+0.90			
DRV370M-4-11	●		37	243	174	148			+0.80			
DRV380M-4-11	●		38	247	178	152			+0.65			
DRV390M-4-11	●		39	251	182	156			+0.55			
S40- DRV400M-4-14	●	2	40	261	192	160	40	49	+1.75	SB-50120TRPH	TTP-20	Outer Edge SCMT140508-□□-E Inner Edge SCMT140510-□□-I
DRV410M-4-14	●		41	265	196	164			+1.60			
DRV420M-4-14	●		42	269	200	168			+1.50			
DRV430M-4-14	●		43	273	204	172			+1.40			
DRV440M-4-14	●		44	277	208	176		+1.30				
DRV450M-4-14	●		45	281	212	180		+1.15				
DRV460M-4-14	●		46	285	216	184		+1.05				
DRV470M-4-14	●		47	289	220	188		+0.95				
S50- DRV480M-4-14	●	2	48	293	224	192	50	59	+0.80	SB-60130TRP	TTP-20	Outer Edge SCMT170608-□□-E Inner Edge SCMT170610-□□-I
DRV490M-4-14	●		49	297	228	196			+0.70			
S50- DRV500M-4-17	●	2	50	298	229	200	50	59	+2.10	SB-60130TRP	TTP-20	Outer Edge SCMT170608-□□-E Inner Edge SCMT170610-□□-I
DRV510M-4-17	●		51	302	233	204			+1.95			
DRV520M-4-17	●		52	306	237	208			+1.85			
DRV530M-4-17	●		53	310	241	212			+1.75			
DRV540M-4-17	●		54	314	245	216			+1.65			
DRV550M-4-17	●		55	318	249	220			+1.50			
DRV560M-4-17	●		56	322	253	224		+1.40				
DRV570M-4-17	●		57	326	257	228		+1.30				
DRV580M-4-17	●		58	330	261	232		+1.15				
DRV590M-4-17	●		59	334	265	236		+1.05				
DRV600M-4-17	●		60	338	269	240		+0.95				

• When offset drilling, reduce feed rate to 0.0024 ipr or less

● : Standard Item

### ■ Estimated Cutting Tolerance (4D)

DC	Estimated Cutting Tolerance (mm)
Ø12mm - Ø39mm	+0.35 0
Ø40m - Ø60mm	+0.40 0

The above values are estimates.

These values may change due to machine, workpiece, clamping power, and cutting conditions

Recommended Cutting Conditions [P26](#)

Adjustable Sleeve SHE [P30](#)

# DRV Toolholders - Metric Sizes

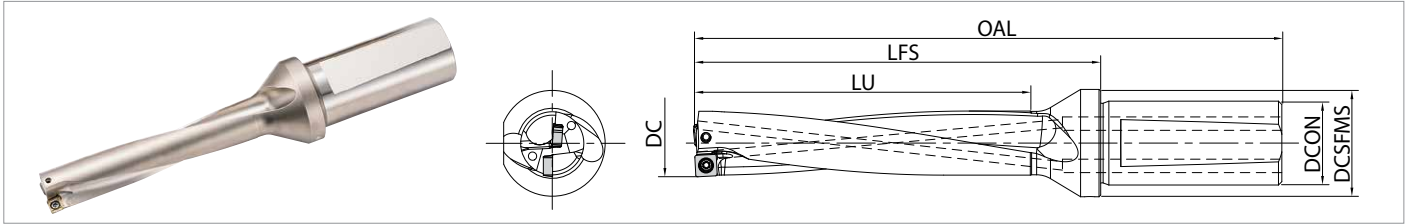

## Toolholder Dimension **5D**

(Drilling Depth : 5 × DC)

Part Number	Stock	No. of Inserts	Dimension (mm)							Max. Radial Offset (mm)	Spare Parts		Applicable Insert See <a href="#">Page 20~21</a>
			DC	OAL	LFS	LU	DCON	DCSFMS	Clamp Screw		Wrench		
S20- DRV120M-5-03	●	2	12	118	75	60	20	27	+0.25	SB-2037TRP	FTP-6	Outer Edge LCMT030203-□□-E Inner Edge LCMT030205-□□-I	
			13	123	80	65			+0.15				
S20- DRV140M-5-04	●	2	14	134	91	70	20	27	+0.40	SB-2037TRP	FTP-6	Outer Edge SCMT040205-□□-E Inner Edge SCMT040209-□□-I	
			15	139	96	75			+0.30				
S25- DRV160M-5-05	●	2	16	158	104	80	25	32	+0.40	SB-2041TRP	FTP-6	Outer Edge SCMT050205-□□-E Inner Edge SCMT050210-□□-I	
			17	163	109	85			+0.30				
			18	168	114	90			+0.20				
S25- DRV190M-5-06	●	2	19	170	116	95	25	32	+0.65	SB-2555TRP	DTPM-8	Outer Edge SCMT060205-□□-E Inner Edge SCMT060210-□□-I	
			20	175	121	100			+0.55				
			21	180	126	105			+0.45				
			22	185	131	110			+0.30				
S25- DRV230M-5-07	●	2	23	190	136	115	25	32	+0.80	SB-3060TRP	DTPM-10	Outer Edge SCMT070305-□□-E Inner Edge SCMT070310-□□-I	
			24	195	141	120			+0.70				
			25	200	146	125			+0.60				
			26	205	151	130			+0.45				
			27	217	158	135			+1.05				
S32- DRV270M-5-09	●	2	28	222	163	140	32	41	+0.95	SB-3573TRP	DTPM-10	Outer Edge SCMT090405-□□-E Inner Edge SCMT090410-□□-I	
			29	227	168	145			+0.85				
			30	232	173	150			+0.75				
			31	237	178	155			+0.60				
			32	242	183	160			+0.50				
			33	260	191	165			+1.25				
S40- DRV330M-5-11	●	2	34	265	196	170	40	49	+1.15	SB-4086TRP	DTPM-15	Outer Edge SCMT110406-□□-E Inner Edge SCMT110410-□□-I	
			35	270	201	175			+1.00				
			36	275	206	180			+0.90				
			37	280	211	185			+0.80				
			38	285	216	190			+0.65				
			39	290	221	195			+0.55				
			40	301	232	200			+1.75				
S40- DRV400M-5-14	●	2	41	306	237	205	40	49	+1.60	SB-50120TRPH	TTP-20	Outer Edge SCMT140508-□□-E Inner Edge SCMT140510-□□-I	
			42	311	242	210			+1.50				
			43	316	247	215			+1.40				
			44	321	252	220			+1.30				
			45	326	257	225			+1.15				
			46	331	262	230		+1.05					
			47	336	267	235		+0.95					
			48	341	272	240		+0.80					
			49	346	277	245		+0.70					
			50	348	279	250		+2.10					
S50- DRV480M-5-14	●	2	51	353	284	255	50	59	+1.95	SB-60130TRP	TTP-20	Outer Edge SCMT170608-□□-E Inner Edge SCMT170610-□□-I	
			52	358	289	260			+1.85				
			53	363	294	265			+1.75				
			54	368	299	270			+1.65				
			55	373	304	275			+1.50				
			56	378	309	280			+1.40				
			57	383	314	285			+1.30				
			58	388	319	290			+1.15				
			59	393	324	295		+1.05					
			60	398	329	300		+0.95					
			61	403	334	305		+0.85					
			62	408	339	310		+0.75					
			63	413	344	315		+0.65					
			64	418	349	320		+0.55					
			65	423	354	325		+0.45					
			66	428	359	330		+0.35					

• When offset drilling, reduce feed rate to 0.0020 ipr or less

● : Standard Item

### ■ Estimated Cutting Tolerance (5D)

DC	Estimated Cutting Tolerance (mm)
Ø12mm - Ø39mm	+0.35 0
Ø40mm - Ø60mm	+0.40 0

The above values are estimates.

These values may change due to machine, workpiece, clamping power, and cutting conditions

Recommended Cutting Conditions **P27**

Adjustable Sleeve SHE **P30**

# DRV Toolholders - Metric Sizes

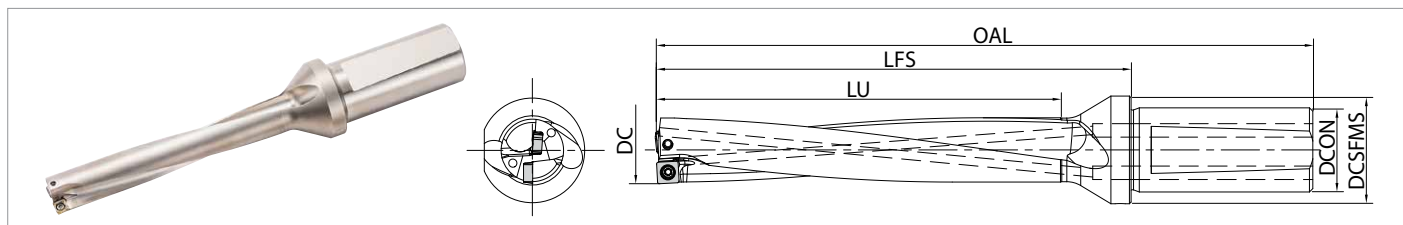

## Toolholder Dimension

6D

(Drilling Depth : 6 × DC)

Part Number	Stock	No. of Inserts	Dimension (mm)						Max. Radial Offset (mm)	Spare Parts		Applicable Insert See <a href="#">Page 20~21</a>	
			DC	OAL	LFS	LU	DCON	DCSFMS		Clamp Screw	Wrench		
S20- DRV120M-6-03	●	2	12	130	87	72	20	27	+0.25	SB-2037TRP	FTP-6	Outer Edge LCMT030203-□□-E Inner Edge LCMT030205-□□-I	
DRV130M-6-03	●		13	136	93	78							+0.15
S20- DRV140M-6-04	●	2	14	148	105	84	20	27	+0.40	SB-2037TRP	FTP-6	Outer Edge SCMT040205-□□-E Inner Edge SCMT040209-□□-I	
DRV150M-6-04	●		15	154	111	90							+0.30
S25- DRV160M-6-05	●	2	16	174	120	96	25	32	+0.40	SB-2041TRP	FTP-6	Outer Edge SCMT050205-□□-E Inner Edge SCMT050210-□□-I	
DRV170M-6-05	●		17	180	126	102							+0.30
DRV180M-6-05	●		18	186	132	108							+0.20
S25- DRV190M-6-06	●	2	19	189	135	114	25	32	+0.65	SB-2555TRP	DTPM-8	Outer Edge SCMT060205-□□-E Inner Edge SCMT060210-□□-I	
DRV200M-6-06	●		20	195	141	120							+0.55
DRV210M-6-06	●		21	201	147	126							+0.45
DRV220M-6-06	●		22	207	153	132							+0.30
S25- DRV230M-6-07	●	2	23	213	159	138	25	32	+0.80	SB-3060TRP	DTPM-10	Outer Edge SCMT070305-□□-E Inner Edge SCMT070310-□□-I	
DRV240M-6-07	●		24	219	165	144							+0.70
DRV250M-6-07	●		25	225	171	150							+0.60
DRV260M-6-07	●		26	231	177	156							+0.45
S32- DRV270M-6-09	●	2	27	244	185	162	32	41	+1.05	SB-3573TRP	DTPM-10	Outer Edge SCMT090405-□□-E Inner Edge SCMT090410-□□-I	
DRV280M-6-09	●		28	250	191	168							+0.95
DRV290M-6-09	●		29	256	197	174							+0.85
DRV300M-6-09	●		30	262	203	180							+0.75
DRV310M-6-09	●		31	268	209	186							+0.60
DRV320M-6-09	●		32	274	215	192							+0.50
S40- DRV330M-6-11	●	2	33	293	224	198	40	49	+1.25	SB-4086TRP	DTPM-15	Outer Edge SCMT110406-□□-E Inner Edge SCMT110410-□□-I	
DRV340M-6-11	●		34	299	230	204							+1.15
DRV350M-6-11	●		35	305	236	210							+1.00
DRV360M-6-11	●		36	311	242	216							+0.90
DRV370M-6-11	●		37	317	248	222							+0.80
DRV380M-6-11	●		38	323	254	228							+0.65
DRV390M-6-11	●		39	329	260	234							+0.55
S40- DRV400M-6-14	●	2	40	341	272	240	40	49	+1.75	SB-50120TRPH	TTP-20	Outer Edge SCMT140508-□□-E Inner Edge SCMT140510-□□-I	
DRV410M-6-14	●		41	347	278	246							+1.60
DRV420M-6-14	●		42	353	284	252							+1.50
DRV430M-6-14	●		43	359	290	258							+1.40
DRV440M-6-14	●		44	365	296	264							+1.30
DRV450M-6-14	●		45	371	302	270							+1.15
S50- DRV500M-6-17	●	2	50	398	329	300	50	59	+2.10	SB-60130TRP	TTP-20	Outer Edge SCMT170608-□□-E Inner Edge SCMT170610-□□-I	
DRV550M-6-17	●		55	428	359	330							+1.50
DRV600M-6-17	●		60	458	389	360							64

• When offset drilling, reduce feed rate to 0.0016 ipr or less

● : Standard Item

### ■ Estimated Cutting Tolerance (6D)

DC	Estimated Cutting Tolerance (mm)
Ø12mm - Ø39mm	+0.45 0
Ø40m - Ø60mm	+0.50 0

The above values are estimates.

These values may change due to machine, workpiece, clamping power, and cutting conditions

Recommended Cutting Conditions [P28](#)

Adjustable Sleeve SHE [P30](#)

# Applicable Outside Inserts

Usage Classification			P	Carbon Steel / Alloy Steel	☆	★		★			
★ : 1st Recommendation (High Speed and Highly Efficient Machining) ☆ : 2nd Recommendation (Stable Machining Oriented)			P	Tool Steel	☆	★		★			
			M	Stainless Steel	☆	★		★			
			K	Cast Iron	☆		★	★			
Insert	Insert Pocket	Part Number	Dimensions (in)				Angle	MEGACOAT	CVD Coated Carbide		MEGACOAT NANO
			IC W1/INSL	S	D1	RE	AN	PR1225	CA520D	CA415D	PR1535
<p>LCMT</p> <p>SCMT</p> <p>General Purpose</p>	Outer Edge	LCMT 030203-GM-E	0.173/0.218	0.079	0.091	0.012	7°	●	●	●	
		SCMT 040205-GM-E	0.189	0.087	0.094	0.020	7°	●	●	●	
		050205-GM-E	0.207	0.102	0.094	0.020	7°	●	●	●	
		060205-GM-E	0.252	0.110	0.114	0.020	7°	●	●	●	
		070305-GM-E	0.301	0.126	0.138	0.020	7°	●	●	●	
		090405-GM-E	0.358	0.161	0.157	0.020	7°	●	●	●	
		110406-GM-E	0.433	0.177	0.181	0.024	7°	●	●	●	
		140508-GM-E	0.543	0.197	0.224	0.031	7°	●	●	●	
<p>LCMT</p> <p>SCMT</p> <p>Tough Edge</p>	Outer Edge	LCMT 030203-GH-E	0.173/0.218	0.079	0.091	0.012	7°	●	●	●	
		SCMT 040205-GH-E	0.189	0.087	0.094	0.020	7°	●	●	●	
		050205-GH-E	0.207	0.102	0.094	0.020	7°	●	●	●	
		060205-GH-E	0.252	0.110	0.114	0.020	7°	●	●	●	
		070305-GH-E	0.301	0.126	0.138	0.020	7°	●	●	●	
		090405-GH-E	0.358	0.161	0.157	0.020	7°	●	●	●	
		110406-GH-E	0.433	0.177	0.181	0.024	7°	●	●	●	
		140508-GH-E	0.543	0.197	0.224	0.031	7°	●	●	●	
<p>SCMT</p> <p>Soft Steel</p>	Outer Edge	SCMT 040205-XM-E	0.189	0.087	0.094	0.020	7°	●	●		
		050205-XM-E	0.207	0.102	0.094	0.020	7°	●	●		
		060205-XM-E	0.252	0.110	0.114	0.020	7°	●	●		
		070305-XM-E	0.301	0.126	0.138	0.020	7°	●	●		
		090405-XM-E	0.358	0.161	0.157	0.020	7°	●	●		
		110406-XM-E	0.433	0.177	0.181	0.024	7°	●	●		
		140508-XM-E	0.543	0.197	0.224	0.031	7°	●	●		
		170608-XM-E	0.661	0.259	0.272	0.031	7°	●	●		
<p>LCMT</p> <p>SCMT</p> <p>Stainless Steel</p>	Outer Edge	LCMT 030203-SM-E	0.173/0.218	0.079	0.091	0.012	7°	●	●		
		SCMT 040205-SM-E	0.189	0.087	0.094	0.020	7°	●	●		
		050205-SM-E	0.207	0.102	0.094	0.020	7°	●	●		
		060205-SM-E	0.252	0.110	0.114	0.020	7°	●	●		
		070305-SM-E	0.301	0.126	0.138	0.020	7°	●	●		
		090405-SM-E	0.358	0.161	0.157	0.020	7°	●	●		
		110406-SM-E	0.433	0.177	0.181	0.024	7°	●	●		
		140508-SM-E	0.543	0.197	0.224	0.031	7°	●	●		
170608-SM-E	0.661	0.259	0.272	0.031	7°	●	●				

● : Standard Item

-E: Outer Edge Insert

-I: Inner Edge Insert

\*LCMT03... is a 2-edge insert

Recommended Cutting Conditions [P25~P28](#)

Inserts are sold in 10 piece boxes

# Applicable Inside Inserts

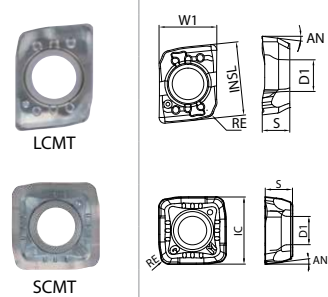
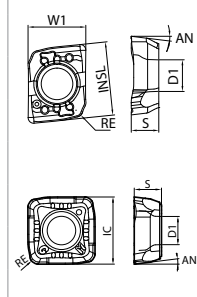
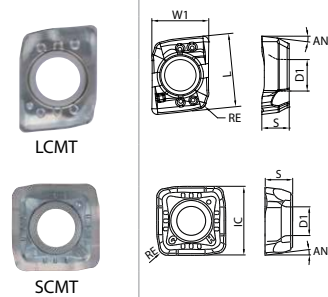
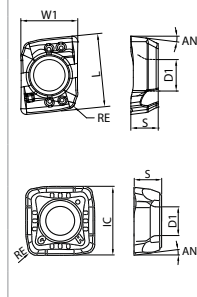
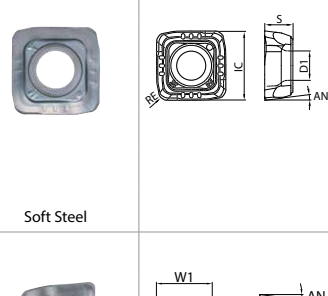
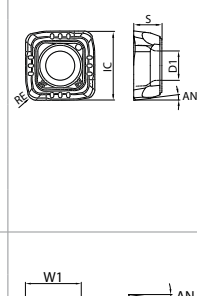
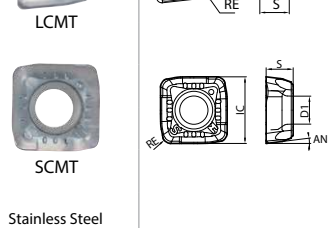
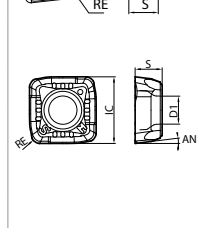
Usage Classification		P	Carbon Steel / Alloy Steel		☆	★		★				
			Tool Steel		☆	★		★				
★ : 1st Recommendation (High Speed and Highly Efficient Machining) ☆ : 2nd Recommendation (Stable Machining Oriented)		M	Stainless Steel		☆	★		★				
			K	Cast Iron		☆		★	★			
Insert	Insert Pocket	Part Number		Dimensions (in)					Angle	MEGACOAT	CVD Coated Carbide	
			IC W1/INSL	S	D1	RE	AN	PR1225	CA520D	CA415D	PR1535	
 <p>LCMT</p> <p>SCMT</p> <p>General Purpose</p>		LCMT 030205-GM-I	0.164/0.211	0.079	0.091	0.020	7°				●	
		SCMT 040209-GM-I	0.197	0.087	0.094	0.035	7°				●	
		050210-GM-I	0.224	0.102	0.094	0.039	7°				●	
		060210-GM-I	0.272	0.110	0.114	0.039	7°				●	
		070310-GM-I	0.323	0.126	0.138	0.039	7°				●	
		090410-GM-I	0.386	0.161	0.157	0.039	7°				●	
		110410-GM-I	0.469	0.177	0.181	0.039	7°				●	
		140510-GM-I	0.587	0.197	0.224	0.039	7°				●	
 <p>LCMT</p> <p>SCMT</p> <p>Tough Edge</p>		LCMT 030205-GH-I	0.164/0.211	0.079	0.091	0.020	7°				●	
		SCMT 040209-GH-I	0.197	0.087	0.094	0.035	7°				●	
		050210-GH-I	0.224	0.102	0.094	0.039	7°				●	
		060210-GH-I	0.272	0.110	0.114	0.039	7°				●	
		070310-GH-I	0.323	0.126	0.138	0.039	7°				●	
		090410-GH-I	0.386	0.161	0.157	0.039	7°				●	
		110410-GH-I	0.469	0.177	0.181	0.039	7°				●	
		140510-GH-I	0.587	0.197	0.224	0.039	7°				●	
 <p>SCMT</p> <p>Soft Steel</p>		SCMT 040209-XM-I	0.197	0.087	0.094	0.035	7°				●	
		050210-XM-I	0.224	0.102	0.094	0.039	7°				●	
		060210-XM-I	0.272	0.110	0.114	0.039	7°				●	
		070310-XM-I	0.323	0.126	0.138	0.039	7°				●	
		090410-XM-I	0.386	0.161	0.157	0.039	7°				●	
		110410-XM-I	0.469	0.177	0.181	0.039	7°				●	
		140510-XM-I	0.587	0.197	0.224	0.039	7°				●	
		170610-XM-I	0.705	0.259	0.272	0.039	7°				●	
 <p>LCMT</p> <p>SCMT</p> <p>Stainless Steel</p>		LCMT 030205-SM-I	0.164/0.211	0.079	0.091	0.020	7°				●	
		SCMT 040209-SM-I	0.197	0.087	0.094	0.035	7°				●	
		050210-SM-I	0.224	0.102	0.094	0.039	7°				●	
		060210-SM-I	0.272	0.110	0.114	0.039	7°				●	
		070310-SM-I	0.323	0.126	0.138	0.039	7°				●	
		090410-SM-I	0.386	0.161	0.157	0.039	7°				●	
		110410-SM-I	0.469	0.177	0.181	0.039	7°				●	
		140510-SM-I	0.587	0.197	0.224	0.039	7°				●	
170610-SM-I	0.705	0.259	0.272	0.039	7°				●			

● : Standard Item

-E : Outer Edge Insert  
 -I : Inner Edge Insert  
 \*LCMT03... is a 2-edge insert

Recommended Cutting Conditions  P25~P28

Inserts are sold in 10 piece boxes

# DRV Chamfering Attachment

Free-positioning according to the drilling depth  
Versatile chamfering with reduced chattering

## 1 Double Inserts Provide Highly Efficient Machining

2 inserts allow for increased feed rates and a low cutting force design reduces chattering

## 2 Excellent Chip Evacuation

Chip flow grooves are designed to follow the flutes of the drill body delivering excellent chip evacuation

## 3 High Chattering Resistance

Molded chipbreaker on 2-edge chamfering insert reduces cutting force while the special insert design prevents fracturing on the edge

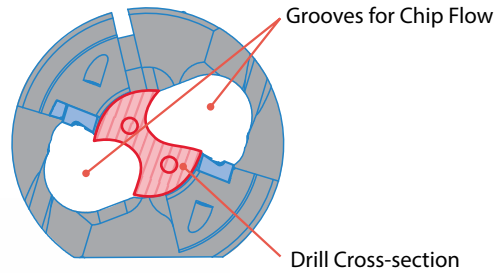

Unique Insert Design

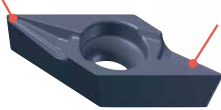

Molded Chipbreaker

Unique insert with 2 cutting edges for chamfering attachment

Two Inserts

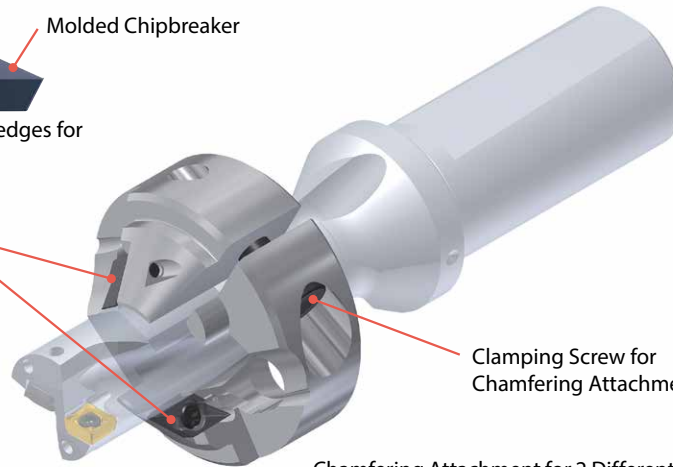

Chamfering Attachment for 2 Different Size Drills

### Chattering Resistance Comparison (Internal Evaluation)

Provided good surface finish on the chamfer without chattering

DRV-CH20  
(Cutting Dia. Ø20mm)



DRV-CH20  
Smooth Surface Without Chattering

Competitor O  
(Cutting Dia. Ø20mm)



Competitor O  
Chattering Occurred on the Chamfer

Cutting Conditions

Vc = 330 sfm  
f = 0.006 ipr

Vc = 390 sfm  
f = 0.004 ipr

Vc = 390 sfm  
f = 0.005 ipr

Workpiece : 1045  
Machine : Machining Center BT-50  
Ø20mm / 3D, H = 30 mm, C2.0



# Chamfering Attachment

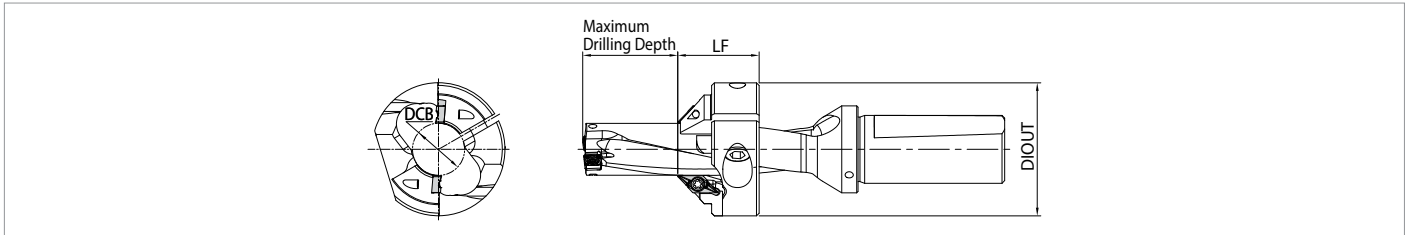

## Chamfer Attachment Dimensions

Part Number	Stock	Applicable Drill Bodies		Dimensions (mm)			Applicable Inserts	Spare Parts			
		Inch Size Bodies	Metric Size Bodies	DIOUT	DCB	LF		Insert Screw	Wrench	Insert Screw	Wrench
DRV-CH17	●	S075-DRV0656-...-05	S25-DRV165M-...-05 S25-DRV170M-...-05	47	16.2	30	CH0503-45	SB-3080TR	FT-10	HH6X18	LW-5
DRV-CH18	●	S100-DRV0688-...-05	S25-DRV175M-...-05 S25-DRV180M-...-05	47	17.2	30					
DRV-CH19	●	-	S25-DRV185M-...-05 S25-DRV190M-...-06	49	18.2	30					
DRV-CH20	●	S100-DRV0766-...-06	S25-DRV195M-...-06 S25-DRV200M-...-06	49	19.2	30					
DRV-CH21	●	S100-DRV0812-...-06	S25-DRV205M-...-06 S25-DRV210M-...-06	49	20.2	30					
DRV-CH22	●	-	S25-DRV215M-...-06 S25-DRV220M-...-06	49	21.2	30					
DRV-CH23	●	-	S25-DRV225M-...-07 S25-DRV230M-...-07	51	22.2	30					
DRV-CH24	●	S100-DRV0938-...-07	S25-DRV235M-...-07 S25-DRV240M-...-07	51	23.2	30					
DRV-CH25	●	S100-DRV0984-...-07	S25-DRV245M-...-07 S25-DRV250M-...-07	53	24.2	30					
DRV-CH26	●	-	S25-DRV255M-...-07 S25-DRV260M-...-07	53	25.2	30					
DRV-CH27	●	S125-DRV1062-...-09	S25-DRV265M-...-09 S32-DRV270M-...-09	64	26	35			HH8X20	LW-6	

● : Standard Item

## Maximum Drilling Depth / Chamfering Depths

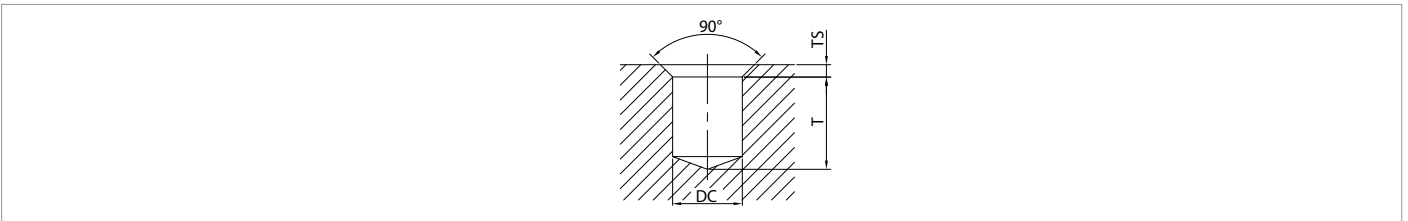

## Chamfer Attachment Dimensions

Drilling Diameter (ØDc)	Maximum Drilling Depth T (mm)						Max Chamfering Depth Ts (mm)	Applicable Chamfering Attachment
	2D Drill	3D Drill	4D Drill	5D Drill	6D Drill			
mm							2.5	
Ø16.5	0.5	17	33.5	-	-			DRV-CH17
Ø17.0	1.5	18.5	35.5	52.5	69.5			DRV-CH18
Ø17.5	2.5	20	37.5	-	-			DRV-CH19
Ø18.0	3.5	21.5	39.5	57.5	75.5			DRV-CH20
Ø18.5	4.5	23	41.5	-	-			DRV-CH21
Ø19.0	5.5	24.5	43.5	62.5	81.5			DRV-CH22
Ø19.5	6.5	26	45.5	-	-			DRV-CH23
Ø20.0	7.5	27.5	47.5	67.5	87.5			DRV-CH24
Ø20.5	8.5	29	49.5	-	-			DRV-CH25
Ø21.0	9.5	30.5	51.5	72.5	93.5			DRV-CH26
Ø21.5	10.5	32	53.5	-	-			DRV-CH27
Ø22.0	11.5	33.5	55.5	77.5	99.5			
Ø22.5	12.5	35	57.5	-	-			
Ø23.0	13.5	36.5	59.5	82.5	105.5			
Ø23.5	14.5	38	61.5	-	-			
Ø24.0	15.5	39.5	63.5	87.5	111.5			
Ø24.5	16.5	41	65.5	-	-			
Ø25.0	17.5	42.5	67.5	92.5	117.5			
Ø25.5	18.5	44	69.5	-	-			
Ø26.0	19.5	45.5	71.5	97.5	123.5			
Ø26.5	-	47	-	-	-			
Ø27.0	16.5	43.5	75.5	97.5	124.5			

# Applicable Chamfering Inserts

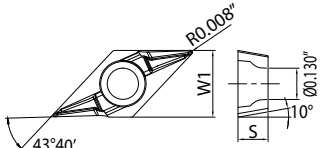
Shape		Part Number	Dimensions (mm)		MEGACOAT NANO PR1535	Applicable Chamfering Attachment
			W1	S		
		CH0503-45	7.05	3.18	○	DRV-CH○○

○ : World Express (Shipping: 7-10 Business Days)

## How to Install Chamfering Attachment

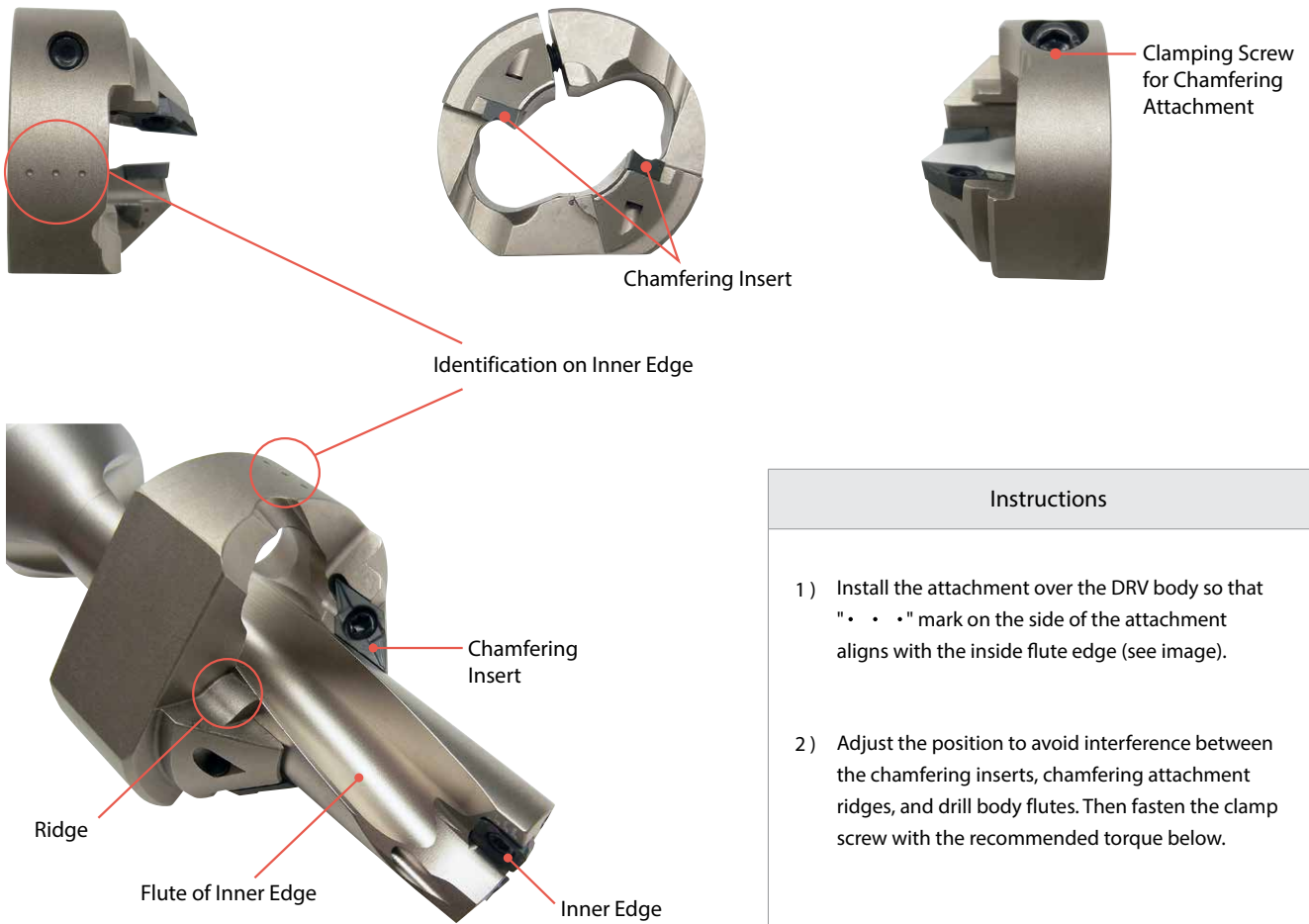

Instructions
1) Install the attachment over the DRV body so that "• • •" mark on the side of the attachment aligns with the inside flute edge (see image).
2) Adjust the position to avoid interference between the chamfering inserts, chamfering attachment ridges, and drill body flutes. Then fasten the clamp screw with the recommended torque below.

## Recommended Torque

Chamfering Attachment Part Number	Torque (Nm)	Clamping Screw	Wrench
DRV-CH17 ~ DRV-CH26	10	HH6X18	LW-5
DRV-CH27	14	HH8X20	LW-6









DRV 2D/3D Recommended Cutting Conditions (with Coolant)

Workpiece Material	Recommended Insert Grade / Cutting Speed (sfm)										Inch Drill Dia. DC (in)	Metric Drill Dia. DC (mm)	Drill Depth / Feed Rate (ipr)				
	PVD Coated Carbide					CVD Coated Carbide							2D~3D				
	PR1225					CA520D				CA415D			GM	GH	XM	SM	
	GM	GH	XM	SM	GM	GH	XM	SM	GM	GH							
Low Carbon Steel	-	-	★ 390-660	☆ 390-660	-	-	★ 490-920	☆ 490-920	-	-	0.484 - 0.531	12.0 - 13.5	-	-	-	0.0016 ~ 0.0024	
	-	-	-	-	-	-	-	-	-	-	0.562 - 0.578	14.0 - 15.5	-	-	0.0016 ~ 0.0035	0.0016 ~ 0.0028	
	-	-	-	-	-	-	-	-	-	-	0.625 - 0.688	16.0 - 18.5	-	-	0.0016 ~ 0.0039	0.0016 ~ 0.0031	
	-	-	-	-	-	-	-	-	-	-	0.750 - 0.875	19.0 - 22.0	-	-	0.0016 ~ 0.0047	0.0016 ~ 0.0031	
	-	-	-	-	-	-	-	-	-	-	0.922 - 1.000	22.5 - 26.0	-	-	0.0016 ~ 0.0055	0.0024 ~ 0.0039	
	-	-	-	-	-	-	-	-	-	-	1.062 - 1.250	26.5 - 32.0	-	-	0.0024 ~ 0.0055	0.0024 ~ 0.0039	
	-	-	-	-	-	-	-	-	-	-	1.312 - 1.500	33.0 - 39.0	-	-	0.0024 ~ 0.0055	0.0024 ~ 0.0039	
	-	-	-	-	-	-	-	-	-	-	1.562 - 2.000	40.0 - 60.0	-	-	0.0024 ~ 0.0063	0.0031 ~ 0.0047	
Carbon Steel	★ 330-590	☆ 330-590	☆ 330-590	☆ 330-590	★ 490-920	☆ 490-920	☆ 490-920	☆ 490-920	-	-	0.484 - 0.531	12.0 - 13.5	0.0016 ~ 0.0055	0.0016 ~ 0.0055	-	0.0016 ~ 0.0039	
	-	-	-	-	-	-	-	-	-	-	0.562 - 0.578	14.0 - 15.5	0.0016 ~ 0.0055	0.0016 ~ 0.0055	0.0016 ~ 0.0039	0.0016 ~ 0.0039	
	-	-	-	-	-	-	-	-	-	-	0.625 - 0.688	16.0 - 18.5	0.0024 ~ 0.0063	0.0024 ~ 0.0063	0.0024 ~ 0.0047	0.0024 ~ 0.0047	
	-	-	-	-	-	-	-	-	-	-	0.750 - 1.000	19.0 - 26.0	0.0031 ~ 0.0079	0.0031 ~ 0.0079	0.0024 ~ 0.0055	0.0024 ~ 0.0055	
	-	-	-	-	-	-	-	-	-	-	1.062 - 1.250	26.5 - 32.0	0.0031 ~ 0.0079	0.0031 ~ 0.0079	0.0024 ~ 0.0055	0.0024 ~ 0.0055	
	-	-	-	-	-	-	-	-	-	-	1.312 - 1.500	33.0 - 39.0	0.0031 ~ 0.0079	0.0031 ~ 0.0079	0.0028 ~ 0.0063	0.0024 ~ 0.0055	
	-	-	-	-	-	-	-	-	-	-	1.562 - 2.000	40.0 - 60.0	0.0031 ~ 0.0079	0.0031 ~ 0.0079	0.0024 ~ 0.0071	0.0024 ~ 0.0055	
	-	-	-	-	-	-	-	-	-	-	0.484 - 0.531	12.0 - 13.5	0.0016 ~ 0.0047	0.0016 ~ 0.0047	-	-	
Alloy Steel	★ 330-525	☆ 330-525	☆ 330-525	-	★ 460-720	☆ 460-720	☆ 460-720	-	-	-	0.562 - 0.578	14.0 - 15.5	0.0016 ~ 0.0055	0.0016 ~ 0.0055	-	-	
	-	-	-	-	-	-	-	-	-	-	0.625 - 0.688	16.0 - 18.5	0.0024 ~ 0.0063	0.0024 ~ 0.0063	-	-	
	-	-	-	-	-	-	-	-	-	-	0.750 - 1.500	19.0 - 39.0	0.0031 ~ 0.0079	0.0031 ~ 0.0079	-	-	
	-	-	-	-	-	-	-	-	-	-	1.562 - 2.000	40.0 - 60.0	0.0031 ~ 0.0079	0.0031 ~ 0.0079	-	-	
Tool Steel	☆ 260-490	★ 260-490	-	-	☆ 425-690	★ 425-690	-	-	-	-	0.500 - 0.578	12.0 - 15.5	0.0016 ~ 0.0031	0.0016 ~ 0.0031	-	-	
	-	-	-	-	-	-	-	-	-	-	0.625 - 0.688	16.0 - 18.5	0.0024 ~ 0.0047	0.0024 ~ 0.0047	-	-	
	-	-	-	-	-	-	-	-	-	-	0.750 - 1.250	19.0 - 32.0	0.0031 ~ 0.0059	0.0031 ~ 0.0059	-	-	
	-	-	-	-	-	-	-	-	-	-	1.312 - 1.500	33.0 - 39.0	0.0031 ~ 0.0059	0.0031 ~ 0.0059	-	-	
Stainless Steel (Austenitic)	-	-	-	★ 230-460	-	-	-	★ 460-660	-	-	0.500 - 0.578	12.0 - 15.5	-	-	-	0.0016 ~ 0.0039	
	-	-	-	-	-	-	-	-	-	-	0.625 - 0.688	16.0 - 18.5	-	-	-	0.0024 ~ 0.0047	
	-	-	-	-	-	-	-	-	-	-	0.750 - 2.000	19.0 - 60.0	-	-	-	0.0024 ~ 0.0055	
Gray Cast Iron	☆ 330-490	★ 330-490	-	-	-	-	-	-	☆ 490-720	★ 490-720	0.484 - 0.531	12.0 - 13.5	0.0031 ~ 0.0055	0.0031 ~ 0.0055	-	-	
	-	-	-	-	-	-	-	-	-	-	0.562 - 0.578	14.0 - 15.5	0.0031 ~ 0.0055	0.0031 ~ 0.0055	-	-	
	-	-	-	-	-	-	-	-	-	-	0.625 - 0.688	16.0 - 18.5	0.0031 ~ 0.0071	0.0031 ~ 0.0071	-	-	
	-	-	-	-	-	-	-	-	-	-	0.750 - 1.500	19.0 - 39.0	0.0031 ~ 0.0079	0.0031 ~ 0.0079	-	-	
Nodular Cast Iron	☆ 260-390	★ 260-390	-	-	-	-	-	-	☆ 390-590	★ 390-590	0.500 - 0.578	12.0 - 15.5	0.0031 ~ 0.0047	0.0031 ~ 0.0047	-	-	
	-	-	-	-	-	-	-	-	-	-	0.625 - 0.688	16.0 - 18.5	0.0031 ~ 0.0063	0.0031 ~ 0.0063	-	-	
	-	-	-	-	-	-	-	-	-	-	0.750 - 1.500	19.0 - 39.0	0.0031 ~ 0.0071	0.0031 ~ 0.0071	-	-	
-	-	-	-	-	-	-	-	-	-	1.562 - 2.000	40.0 - 60.0	0.0031 ~ 0.0071	0.0031 ~ 0.0071	-	-		

• Internal Coolant is Recommended

Cutting Conditions by Application







Applications	Plain Surface	Angled Surface	Half Cylindrical	Hole Expansion	Existing Hole	Concave Surface	Stacked Plates
Workpiece Shape							
Cutting Speed Vc (sfm)	See recommended cutting conditions above	390 (PVD insert is recommended for outer edge)					Not Recommended
f (ipr)	See recommended cutting conditions above	50% of above recommendation				50% of above recommendation initially. See recommendations above once drill is fully engaged.	Not Available
Internal Coolant	Yes						Not Recommended

DRV 4D Recommended Cutting Conditions (with Coolant)

Workpiece Material	Recommended Insert Grade / Cutting Speed (sfm)										Inch Drill Dia. DC (in)	Metric Drill Dia. DC (mm)	Drill Depth / Feed Rate (ipr)				
	PVD Coated Carbide					CVD Coated Carbide							4D				
	PR1225					CA520D				CA415D			GM	GH	XM	SM	
	GM	GH	XM	SM	GM	GH	XM	SM	GM	GH							
Low Carbon Steel	-	-	★ 390-660	☆ 390-660	-	-	★ 490-920	☆ 490-920	-	-	0.484 - 0.531	12.0 - 13.5	-	-	-	0.0016 ~ 0.0024	
	-	-	-	-	-	-	-	-	-	-	0.562 - 0.578	14.0 - 15.5	-	-	0.0016 ~ 0.0031	0.0016 ~ 0.0028	
	-	-	-	-	-	-	-	-	-	-	0.625 - 0.688	16.0 - 18.5	-	-	0.0016 ~ 0.0031	0.0016 ~ 0.0031	
	-	-	-	-	-	-	-	-	-	-	0.750 - 0.875	19.0 - 22.0	-	-	0.0016 ~ 0.0039	0.0016 ~ 0.0031	
	-	-	-	-	-	-	-	-	-	-	0.922 - 1.000	22.5 - 26.0	-	-	0.0016 ~ 0.0047	0.0020 ~ 0.0039	
	-	-	-	-	-	-	-	-	-	-	1.062 - 1.250	26.5 - 32.0	-	-	0.0016 ~ 0.0047	0.0020 ~ 0.0039	
	-	-	-	-	-	-	-	-	-	-	1.312 - 1.500	33.0 - 39.0	-	-	0.0024 ~ 0.0047	0.0020 ~ 0.0039	
	-	-	-	-	-	-	-	-	-	-	1.562 - 2.000	40.0 - 60.0	-	-	0.0024 ~ 0.0063	0.0020 ~ 0.0039	
Carbon Steel	★ 330-590	☆ 330-590	☆ 330-590	☆ 330-590	★ 490-920	☆ 490-920	☆ 490-920	☆ 490-920	-	-	0.484 - 0.531	12.0 - 13.5	0.0016 ~ 0.0039	0.0016 ~ 0.0039	-	0.0016 ~ 0.0031	
	-	-	-	-	-	-	-	-	-	-	0.562 - 0.578	14.0 - 15.5	0.0016 ~ 0.0039	0.0016 ~ 0.0039	0.0016 ~ 0.0031	0.0016 ~ 0.0031	
	-	-	-	-	-	-	-	-	-	-	0.625 - 0.688	16.0 - 18.5	0.0020 ~ 0.0047	0.0020 ~ 0.0047	0.0016 ~ 0.0039	0.0020 ~ 0.0039	
	-	-	-	-	-	-	-	-	-	-	0.750 - 1.000	19.0 - 26.0	0.0028 ~ 0.0063	0.0028 ~ 0.0063	0.0016 ~ 0.0047	0.0020 ~ 0.0047	
	-	-	-	-	-	-	-	-	-	-	1.062 - 1.250	26.5 - 32.0	0.0028 ~ 0.0063	0.0028 ~ 0.0063	0.0016 ~ 0.0047	0.0020 ~ 0.0047	
	-	-	-	-	-	-	-	-	-	-	1.312 - 1.500	33.0 - 39.0	0.0028 ~ 0.0063	0.0028 ~ 0.0063	0.0024 ~ 0.0055	0.0020 ~ 0.0047	
	-	-	-	-	-	-	-	-	-	-	1.562 - 2.000	40.0 - 60.0	0.0028 ~ 0.0063	0.0028 ~ 0.0063	0.0024 ~ 0.0063	0.0020 ~ 0.0047	
	-	-	-	-	-	-	-	-	-	-	0.484 - 0.531	12.0 - 13.5	0.0016 ~ 0.0039	0.0016 ~ 0.0039	-	-	
Alloy Steel	★ 330-525	☆ 330-525	☆ 330-525	-	★ 460-720	☆ 460-720	☆ 460-720	-	-	-	0.562 - 0.578	14.0 - 15.5	0.0016 ~ 0.0039	0.0016 ~ 0.0039	-	-	
	-	-	-	-	-	-	-	-	-	-	0.625 - 0.688	16.0 - 18.5	0.0020 ~ 0.0047	0.0020 ~ 0.0047	-	-	
	-	-	-	-	-	-	-	-	-	-	0.750 - 1.500	19.0 - 39.0	0.0028 ~ 0.0063	0.0028 ~ 0.0063	-	-	
	-	-	-	-	-	-	-	-	-	-	1.562 - 2.000	40.0 - 60.0	0.0028 ~ 0.0063	0.0028 ~ 0.0063	-	-	
Tool Steel	☆ 260-490	★ 260-490	-	-	☆ 425-690	★ 425-690	-	-	-	-	0.500 - 0.578	12.0 - 15.5	0.0016 ~ 0.0028	0.0016 ~ 0.0028	-	-	
	-	-	-	-	-	-	-	-	-	-	0.625 - 0.688	16.0 - 18.5	0.0020 ~ 0.0039	0.0020 ~ 0.0039	-	-	
	-	-	-	-	-	-	-	-	-	-	0.750 - 1.250	19.0 - 32.0	0.0024 ~ 0.0047	0.0024 ~ 0.0047	-	-	
	-	-	-	-	-	-	-	-	-	-	1.312 - 1.500	33.0 - 39.0	0.0024 ~ 0.0047	0.0024 ~ 0.0047	-	-	
Stainless Steel (Austenitic)	-	-	-	★ 230-460	-	-	-	★ 460-660	-	-	0.500 - 0.578	12.0 - 15.5	-	-	-	0.0016 ~ 0.0031	
	-	-	-	-	-	-	-	-	-	-	0.625 - 0.688	16.0 - 18.5	-	-	-	0.0020 ~ 0.0043	
	-	-	-	-	-	-	-	-	-	-	0.750 - 2.000	19.0 - 60.0	-	-	-	0.0024 ~ 0.0047	
Gray Cast Iron	☆ 330-490	★ 330-490	-	-	-	-	-	-	☆ 490-720	★ 490-720	0.484 - 0.531	12.0 - 13.5	0.0024 ~ 0.0039	0.0024 ~ 0.0039	-	-	
	-	-	-	-	-	-	-	-	-	-	0.562 - 0.578	14.0 - 15.5	0.0024 ~ 0.0047	0.0024 ~ 0.0047	-	-	
	-	-	-	-	-	-	-	-	-	-	0.625 - 0.688	16.0 - 18.5	0.0031 ~ 0.0063	0.0031 ~ 0.0063	-	-	
	-	-	-	-	-	-	-	-	-	-	0.750 - 1.500	19.0 - 39.0	0.0031 ~ 0.0071	0.0031 ~ 0.0071	-	-	
	-	-	-	-	-	-	-	-	-	-	1.562 - 2.000	40.0 - 60.0	0.0031 ~ 0.0071	0.0031 ~ 0.0071	-	-	
Nodular Cast Iron	☆ 260-390	★ 260-390	-	-	-	-	-	-	☆ 390-590	★ 390-590	0.500 - 0.578	12.0 - 15.5	0.0024 ~ 0.0039	0.0024 ~ 0.0039	-	-	
	-	-	-	-	-	-	-	-	-	-	0.625 - 0.688	16.0 - 18.5	0.0031 ~ 0.0055	0.0031 ~ 0.0055	-	-	
	-	-	-	-	-	-	-	-	-	-	0.750 - 1.500	19.0 - 39.0	0.0031 ~ 0.0063	0.0031 ~ 0.0063	-	-	
-	-	-	-	-	-	-	-	-	-	-	1.562 - 2.000	40.0 - 60.0	0.0031 ~ 0.0063	0.0031 ~ 0.0063	-	-	

• Internal Coolant is Recommended

Cutting Conditions by Application







Applications	Plain Surface	Angled Surface	Half Cylindrical	Hole Expansion	Existing Hole	Concave Surface	Stacked Plates
Workpiece Shape							
Cutting Speed Vc (sfm)	See recommended cutting conditions above	390 (PVD insert is recommended for outer edge)					Not Recommended
f (ipr)	See recommended cutting conditions above	50% of above recommendation				50% of above recommendation initially. See recommendations above once drill is fully engaged.	Not Available
Internal Coolant	Yes						Not Recommended

DRV 5D Recommended Cutting Conditions (with Coolant)

Workpiece Material	Recommended Insert Grade / Cutting Speed (sfm)										Inch Drill Dia. DC (in)	Metric Drill Dia. DC (mm)	Drill Depth / Feed Rate (ipr)			
	PVD Coated Carbide					CVD Coated Carbide							5D			
	PR1225			CA520D				CA415D								
	GM	GH	XM	SM	GM	GH	XM	SM	GM	GH			GM	GH	XM	SM
Low Carbon Steel	-	-	★ 390-660	☆ 390-660	-	-	★ 490-920	☆ 490-920	-	-	0.484 - 0.531	12.0 - 13.5	-	-	-	0.0012 ~ 0.0020
	-	-	-	-	-	-	-	-	-	-	0.562 - 0.578	14.0 - 15.5	-	-	0.0016 ~ 0.0028	0.0016 ~ 0.0024
	-	-	-	-	-	-	-	-	-	-	0.625 - 0.688	16.0 - 18.5	-	-	0.0016 ~ 0.0031	0.0016 ~ 0.0024
	-	-	-	-	-	-	-	-	-	-	0.750 - 0.875	19.0 - 22.0	-	-	0.0016 ~ 0.0039	0.0016 ~ 0.0028
	-	-	-	-	-	-	-	-	-	-	0.922 - 1.000	22.5 - 26.0	-	-	0.0016 ~ 0.0047	0.0016 ~ 0.0031
	-	-	-	-	-	-	-	-	-	-	1.062 - 1.250	26.5 - 32.0	-	-	0.0016 ~ 0.0047	0.0016 ~ 0.0031
	-	-	-	-	-	-	-	-	-	-	1.312 - 1.500	33.0 - 39.0	-	-	0.0020 ~ 0.0047	0.0016 ~ 0.0039
	-	-	-	-	-	-	-	-	-	-	1.562 - 2.000	40.0 - 60.0	-	-	0.0020 ~ 0.0055	0.0016 ~ 0.0039
Carbon Steel	★ 330-590	☆ 330-590	☆ 330-590	☆ 330-590	★ 490-920	☆ 490-920	☆ 490-920	☆ 490-920	-	-	0.484 - 0.531	12.0 - 13.5	0.0016 ~ 0.0031	0.0016 ~ 0.0031	-	0.0016 ~ 0.0028
	-	-	-	-	-	-	-	-	-	-	0.562 - 0.578	14.0 - 15.5	0.0016 ~ 0.0031	0.0016 ~ 0.0031	0.0016 ~ 0.0028	0.0016 ~ 0.0028
	-	-	-	-	-	-	-	-	-	-	0.625 - 0.688	16.0 - 18.5	0.0020 ~ 0.0039	0.0020 ~ 0.0039	0.0020 ~ 0.0031	0.0020 ~ 0.0031
	-	-	-	-	-	-	-	-	-	-	0.750 - 1.000	19.0 - 26.0	0.0024 ~ 0.0047	0.0024 ~ 0.0047	0.0020 ~ 0.0039	0.0020 ~ 0.0039
	-	-	-	-	-	-	-	-	-	-	1.062 - 1.250	26.5 - 32.0	0.0024 ~ 0.0047	0.0024 ~ 0.0047	0.0020 ~ 0.0047	0.0020 ~ 0.0039
	-	-	-	-	-	-	-	-	-	-	1.312 - 1.500	33.0 - 39.0	0.0024 ~ 0.0047	0.0024 ~ 0.0047	0.0020 ~ 0.0047	0.0020 ~ 0.0039
	-	-	-	-	-	-	-	-	-	-	1.562 - 2.000	40.0 - 60.0	0.0024 ~ 0.0047	0.0024 ~ 0.0047	0.0024 ~ 0.0047	0.0020 ~ 0.0039
	-	-	-	-	-	-	-	-	-	-	-	-	-	-	-	-
Alloy Steel	★ 330-525	☆ 330-525	☆ 330-525	-	★ 460-720	☆ 460-720	☆ 460-720	-	-	-	0.484 - 0.531	12.0 - 13.5	0.0016 ~ 0.0031	0.0016 ~ 0.0031	-	-
	-	-	-	-	-	-	-	-	-	-	0.562 - 0.578	14.0 - 15.5	0.0016 ~ 0.0031	0.0016 ~ 0.0031	-	-
	-	-	-	-	-	-	-	-	-	-	0.625 - 0.688	16.0 - 18.5	0.0020 ~ 0.0039	0.0020 ~ 0.0039	-	-
	-	-	-	-	-	-	-	-	-	-	0.750 - 1.500	19.0 - 39.0	0.0024 ~ 0.0047	0.0024 ~ 0.0047	-	-
	-	-	-	-	-	-	-	-	-	-	1.562 - 2.000	40.0 - 60.0	0.0024 ~ 0.0047	0.0024 ~ 0.0047	-	-
Tool Steel	☆ 260-490	★ 260-490	-	-	☆ 425-690	★ 425-690	-	-	-	-	0.484 - 0.531	12.0 - 13.5	0.0016 ~ 0.0024	0.0016 ~ 0.0024	-	-
	-	-	-	-	-	-	-	-	-	-	0.562 - 0.578	14.0 - 15.5	0.0016 ~ 0.0024	0.0016 ~ 0.0024	-	-
	-	-	-	-	-	-	-	-	-	-	0.625 - 0.688	16.0 - 18.5	0.0016 ~ 0.0031	0.0016 ~ 0.0031	-	-
	-	-	-	-	-	-	-	-	-	-	0.750 - 1.500	19.0 - 39.0	0.0020 ~ 0.0039	0.0020 ~ 0.0039	-	-
	-	-	-	-	-	-	-	-	-	-	1.562 - 2.000	40.0 - 60.0	0.0020 ~ 0.0039	0.0020 ~ 0.0039	-	-
Stainless Steel (Austenitic)	-	-	-	★ 230-460	-	-	-	★ 460-660	-	-	0.484 - 0.531	12.0 - 13.5	-	-	-	0.0016 ~ 0.0031
	-	-	-	-	-	-	-	-	-	-	0.562 - 0.578	14.0 - 15.5	-	-	-	0.0016 ~ 0.0031
	-	-	-	-	-	-	-	-	-	-	0.625 - 0.688	16.0 - 18.5	-	-	-	0.0016 ~ 0.0039
	-	-	-	-	-	-	-	-	-	-	0.750 - 2.000	19.0 - 60.0	-	-	-	0.0024 ~ 0.0047
Gray Cast Iron	☆ 330-490	★ 330-490	-	-	-	-	-	-	☆ 490-720	★ 490-720	0.500 - 0.578	12.0 - 15.5	0.0016 ~ 0.0039	0.0016 ~ 0.0039	-	-
	-	-	-	-	-	-	-	-	-	-	0.625 - 0.688	16.0 - 18.5	0.0024 ~ 0.0047	0.0024 ~ 0.0047	-	-
	-	-	-	-	-	-	-	-	-	-	0.750 - 1.500	19.0 - 39.0	0.0024 ~ 0.0055	0.0024 ~ 0.0055	-	-
	-	-	-	-	-	-	-	-	-	-	1.562 - 2.000	40.0 - 60.0	0.0024 ~ 0.0055	0.0024 ~ 0.0055	-	-
Nodular Cast Iron	☆ 260-390	★ 260-390	-	-	-	-	-	-	☆ 390-590	★ 390-590	0.484 - 0.531	12.0 - 13.5	0.0016 ~ 0.0031	0.0016 ~ 0.0031	-	-
	-	-	-	-	-	-	-	-	-	-	0.562 - 0.578	14.0 - 15.5	0.0016 ~ 0.0031	0.0016 ~ 0.0031	-	-
	-	-	-	-	-	-	-	-	-	-	0.625 - 0.688	16.0 - 18.5	0.0024 ~ 0.0039	0.0024 ~ 0.0039	-	-
	-	-	-	-	-	-	-	-	-	-	0.750 - 1.500	19.0 - 39.0	0.0024 ~ 0.0047	0.0024 ~ 0.0047	-	-
-	-	-	-	-	-	-	-	-	-	1.562 - 2.000	40.0 - 60.0	0.0024 ~ 0.0047	0.0024 ~ 0.0047	-	-	

• Internal Coolant is Recommended

Cutting Conditions by Application

Applications	Plain Surface	Angled Surface	Half Cylindrical	Hole Expansion	Existing Hole	Concave Surface	Stacked Plates
Workpiece Shape							
Cutting Speed Vc (sfm)	See recommended cutting conditions above	390 (PVD insert is recommended for outer edge)					Not Recommended
f (ipr)	See recommended cutting conditions above	50% of above recommendation				50% of above recommendation initially. See recommendations above once drill is fully engaged.	Not Available
Internal Coolant	Yes						Not Recommended

DRV 6D Recommended Cutting Conditions (with Coolant)

Workpiece Material	Recommended Insert Grade / Cutting Speed (sfm)										Inch Drill Dia. DC (in)	Metric Drill Dia. DC (mm)	Drill Depth / Feed Rate (ipr)			
	PVD Coated Carbide					CVD Coated Carbide							6D			
	PR1225		CA520D			CA415D										
	GM	GH	XM	SM	GM	GH	XM	SM	GM	GH			GM	GH	XM	SM
Low Carbon Steel	-	-	★	☆	-	-	★	☆	-	-	0.484 - 0.531	12.0 - 13.5	-	-	-	0.0012 ~ 0.0020
	-	-	★	☆	-	-	★	☆	-	-	0.562 - 0.578	14.0 - 15.5	-	-	0.0016 ~ 0.0024	0.0016 ~ 0.0024
	-	-	★	☆	-	-	★	☆	-	-	0.625 - 0.688	16.0 - 18.5	-	-	0.0016 ~ 0.0024	0.0016 ~ 0.0024
	-	-	★	☆	-	-	★	☆	-	-	0.750 - 0.875	19.0 - 22.0	-	-	0.0016 ~ 0.0028	0.0016 ~ 0.0028
	-	-	★	☆	-	-	★	☆	-	-	0.922 - 1.000	22.5 - 26.0	-	-	0.0016 ~ 0.0031	0.0016 ~ 0.0028
	-	-	★	☆	-	-	★	☆	-	-	1.062 - 1.250	26.5 - 32.0	-	-	0.0016 ~ 0.0031	0.0016 ~ 0.0028
	-	-	★	☆	-	-	★	☆	-	-	1.312 - 1.500	33.0 - 39.0	-	-	0.0016 ~ 0.0035	0.0016 ~ 0.0031
	-	-	★	☆	-	-	★	☆	-	-	1.562 - 2.000	40.0 - 60.0	-	-	0.0024 ~ 0.0047	0.0016 ~ 0.0031
Carbon Steel	★	☆	☆	☆	★	☆	☆	☆	-	-	0.484 - 0.531	12.0 - 13.5	0.0012 ~ 0.0020	0.0012 ~ 0.0020	-	0.0012 ~ 0.0020
	★	☆	☆	☆	★	☆	☆	☆	-	-	0.562 - 0.578	14.0 - 15.5	0.0016 ~ 0.0024	0.0016 ~ 0.0024	0.0016 ~ 0.0024	0.0016 ~ 0.0024
	★	☆	☆	☆	★	☆	☆	☆	-	-	0.625 - 0.688	16.0 - 18.5	0.0020 ~ 0.0031	0.0020 ~ 0.0031	0.0020 ~ 0.0028	0.0020 ~ 0.0028
	★	☆	☆	☆	★	☆	☆	☆	-	-	0.750 - 1.000	19.0 - 26.0	0.0024 ~ 0.0039	0.0024 ~ 0.0039	0.0020 ~ 0.0031	0.0020 ~ 0.0031
	★	☆	☆	☆	★	☆	☆	☆	-	-	1.062 - 1.250	26.5 - 32.0	0.0024 ~ 0.0039	0.0024 ~ 0.0039	0.0020 ~ 0.0031	0.0020 ~ 0.0031
	★	☆	☆	☆	★	☆	☆	☆	-	-	1.312 - 1.500	33.0 - 39.0	0.0024 ~ 0.0039	0.0024 ~ 0.0039	0.0020 ~ 0.0031	0.0020 ~ 0.0031
	★	☆	☆	☆	★	☆	☆	☆	-	-	1.562 - 2.000	40.0 - 60.0	0.0024 ~ 0.0039	0.0024 ~ 0.0039	0.0024 ~ 0.0039	0.0020 ~ 0.0031
	★	☆	☆	☆	★	☆	☆	☆	-	-	0.484 - 0.531	12.0 - 13.5	0.0012 ~ 0.0020	0.0012 ~ 0.0020	-	-
Alloy Steel	★	☆	☆	-	★	☆	☆	-	-	-	0.562 - 0.578	14.0 - 15.5	0.0016 ~ 0.0024	0.0016 ~ 0.0024	-	-
	★	☆	☆	-	★	☆	☆	-	-	-	0.625 - 0.688	16.0 - 18.5	0.0020 ~ 0.0031	0.0020 ~ 0.0031	-	-
	★	☆	☆	-	★	☆	☆	-	-	-	0.750 - 1.500	19.0 - 39.0	0.0024 ~ 0.0039	0.0024 ~ 0.0039	-	-
	★	☆	☆	-	★	☆	☆	-	-	-	1.562 - 2.000	40.0 - 60.0	0.0024 ~ 0.0039	0.0024 ~ 0.0039	-	-
Tool Steel	☆	★	-	-	☆	★	-	-	-	-	0.484 - 0.531	12.0 - 13.5	0.0012 ~ 0.0020	0.0012 ~ 0.0020	-	-
	☆	★	-	-	☆	★	-	-	-	-	0.562 - 0.578	14.0 - 15.5	0.0016 ~ 0.0020	0.0016 ~ 0.0020	-	-
	☆	★	-	-	☆	★	-	-	-	-	0.625 - 0.688	16.0 - 18.5	0.0016 ~ 0.0024	0.0016 ~ 0.0024	-	-
	☆	★	-	-	☆	★	-	-	-	-	0.750 - 1.500	19.0 - 39.0	0.0020 ~ 0.0031	0.0020 ~ 0.0031	-	-
Stainless Steel (Austenitic)	-	-	-	★	-	-	-	★	-	-	0.484 - 0.531	12.0 - 13.5	-	-	-	0.0012 ~ 0.0020
	-	-	-	★	-	-	-	★	-	-	0.562 - 0.578	14.0 - 15.5	-	-	-	0.0016 ~ 0.0024
	-	-	-	★	-	-	-	★	-	-	0.625 - 0.688	16.0 - 18.5	-	-	-	0.0016 ~ 0.0035
	-	-	-	★	-	-	-	★	-	-	0.750 - 2.000	19.0 - 60.0	-	-	-	0.0024 ~ 0.0039
Gray Cast Iron	☆	★	-	-	-	-	-	☆	★	-	0.500 - 0.578	12.0 - 15.5	0.0016 ~ 0.0031	0.0016 ~ 0.0031	-	-
	☆	★	-	-	-	-	-	☆	★	-	0.625 - 0.688	16.0 - 18.5	0.0024 ~ 0.0039	0.0024 ~ 0.0039	-	-
	☆	★	-	-	-	-	-	☆	★	-	0.750 - 1.500	19.0 - 39.0	0.0024 ~ 0.0047	0.0024 ~ 0.0047	-	-
	☆	★	-	-	-	-	-	☆	★	-	1.562 - 2.000	40.0 - 60.0	0.0024 ~ 0.0047	0.0024 ~ 0.0047	-	-
Nodular Cast Iron	☆	★	-	-	-	-	-	☆	★	-	0.484 - 0.531	12.0 - 13.5	0.0012 ~ 0.0020	0.0012 ~ 0.0020	-	-
	☆	★	-	-	-	-	-	☆	★	-	0.562 - 0.578	14.0 - 15.5	0.0016 ~ 0.0024	0.0016 ~ 0.0024	-	-
	☆	★	-	-	-	-	-	☆	★	-	0.625 - 0.688	16.0 - 18.5	0.0024 ~ 0.0031	0.0024 ~ 0.0031	-	-
	☆	★	-	-	-	-	-	☆	★	-	0.750 - 1.500	19.0 - 39.0	0.0024 ~ 0.0039	0.0024 ~ 0.0039	-	-
☆	★	-	-	-	-	-	☆	★	-	1.562 - 2.000	40.0 - 60.0	0.0024 ~ 0.0039	0.0024 ~ 0.0039	-	-	

• Internal Coolant is Recommended

Cutting Conditions by Application

Applications	Plain Surface	Angled Surface	Half Cylindrical	Hole Expansion	Existing Hole	Concave Surface	Stacked Plates
Workpiece Shape							
Cutting Speed Vc (sfm)	See recommended cutting conditions above	390 (PVD insert is recommended for outer edge)					Not Recommended
f (ipr)	See recommended cutting conditions above	50% of above recommendation				50% of above recommendation initially. See recommendations above once drill is fully engaged.	Not Available
Internal Coolant	Yes						Not Recommended

# Insert Grade Selection Guide

Select CVD for the outer edge when performing high speed and high efficiency drilling and for abrasion resistance and long tool life.

Select PVD MEGACOAT for the outer edge for stable machining and a better surface finish.

PVD MEGACOAT is recommended for the outer edge if chattering occurs, machining with lathe, or if cutting conditions cannot be increased to the recommended speed for CVD.

### 1st Recommendation

(High Speed and High Efficiency Machining)

Outer Edge : CVD (CA520D / CA415D)

Inner Edge : PVD (PR1535)



### Stable Machining Oriented

(1st Recommendation for Lathe Machining)

Outer Edge : PVD (PR1225)

Inner Edge : PVD (PR1535)



## Shape of the Hole Bottom

DRV Inch Diameters (in)			DRV Metric Diameters (mm)											
Insert Size	DC	A	Insert Size	DC	A	Insert Size	DC	A	Insert Size	DC	A	Insert Size	DC	A
03	0.500	0.028	03	12.0	0.7	06	19.0	1.2	09	26.5	1.2	14	40.0	1.9
04	0.562	0.039		12.5			19.5			27.0			41.0	
05	0.625	0.043		13.0			20.0			27.5			42.0	
	0.656		13.5	20.5	28.0	43.0								
06	0.688	0.047	04	14.0	1.0	07	21.0	1.3	11	28.5	1.3	17	44.0	2.0
	0.750			14.5			21.5			29.0			45.0	
	0.812			15.0			22.0			29.5			46.0	
07	0.875	0.051	05	15.5	1.1	07	22.5	1.2	11	30.0	1.4	17	47.0	2.1
	0.938			16.0			23.0			30.5			48.0	
09	0.984	0.051	05	16.5	1.1	07	23.5	1.2	11	31.0	1.5	17	49.0	2.2
	1.000			17.0			24.0			31.5			50.0	
	1.062			17.5			24.5			32.0			51.0	
11	1.125	0.051	05	18.0	1.2	07	25.0	1.3	11	33.0	1.5	17	52.0	2.1
	1.188			18.5			25.5			34.0			53.0	
	1.250			19.0			26.0			35.0			54.0	
14	1.312	0.059	05	18.5	1.2	07	26.0	1.3	11	36.0	1.6	17	55.0	2.2
	1.375									37.0			56.0	
	1.438									38.0			57.0	
	1.500									39.0			58.0	
17	1.562	0.075	05	19.0	1.2	07	26.5	1.3	11	39.0	1.7	17	59.0	2.4
	1.625									40.0			60.0	
	1.688									41.0				
	1.750									42.0				
14	1.812	0.079	05	19.5	1.2	07	27.0	1.3	11	43.0	1.5	17	61.0	2.3
	1.875									44.0				
	1.938									45.0				
17	2.000	0.083	05	20.0	1.2	07	27.5	1.3	11	44.0	1.6	17	62.0	2.4
										45.0				

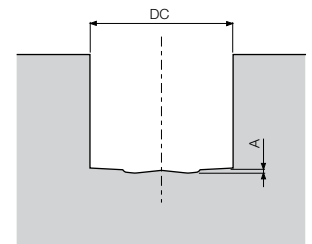

Common for 2D, 3D, 4D, 5D, 6D Drills

\*Above is estimated values. (varies within  $\pm 0.004''$  ( $\pm 0.1\text{mm}$ ) depending on workpiece material and cutting conditions)

## Machining Caution

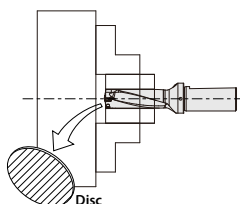

In case of through-hole machining, a disc may be generated and ejected outward when exiting the hole.

Be sure to install guards to protect against dangers if using a machine without the covers (including general-purpose lathes, etc.).

# Adjustable Sleeve (Cutting Diameter & Center Height Adjustment)

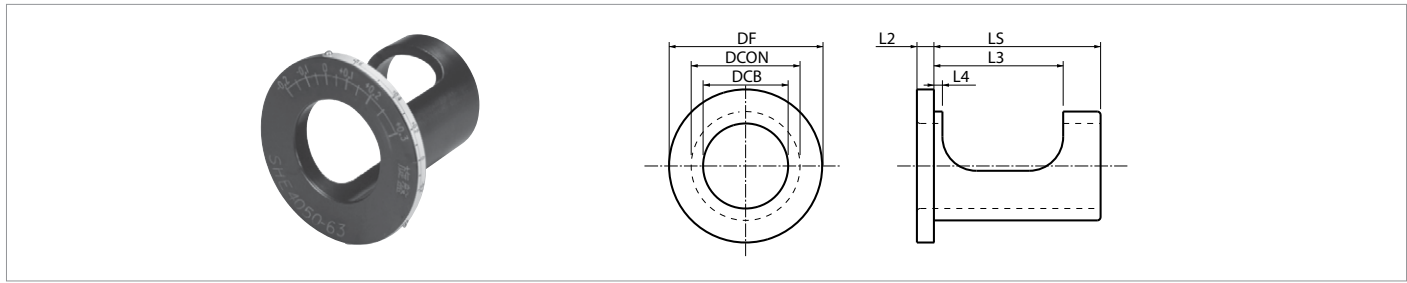

## Sleeve Dimensions (Use ASL for Inch Size Drills and SHE for Metric Size Drills)

Part Number	Stock	Unit	Dimension							Diameter Adjustment Range	Center Height Adjustment Range
			DCB	DCON	DF	LS	L2	L3	L4		
ASL 75100-175	●	inch	0.750	1.000	1.614	1.750	0.157	1.417	0.118	+0.016 ~ -0.008	+0.008 ~ -0.006
100125-212	●		1.000	1.250	1.929	2.125	0.236	1.496	0.098	+0.016 ~ -0.008	+0.008 ~ -0.006
125150-238	●		1.250	1.500	2.283	2.375	0.236	1.693	0.098	+0.016 ~ -0.008	+0.008 ~ -0.006
SHE 2025-43	●	mm	20	25	41	43	4	36	3.0	+0.4 ~ -0.2	+0.2 ~ -0.15
2532-48	●		25	32	49	48	6	38	2.5	+0.4 ~ -0.2	+0.2 ~ -0.15
3240-53	●		32	40	58	53	6	43	2.5	+0.4 ~ -0.2	+0.2 ~ -0.15
4050-63	●		40	50	74	63	6	49	3.0	+0.4 ~ -0.2	+0.3 ~ -0.20

- Diameter adjustment range refers to the cutting diameter.
- ASL and SHE sleeves can also be used with the DRX and DRZ Magic Drills

● : Standard Item

### 1 Diameter Adjustment ~ For Machining Center ~

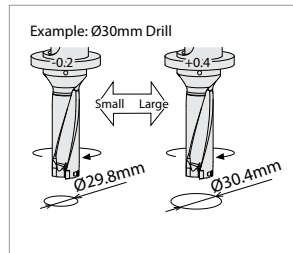

#### • Diameter Adjustment

ASL (in)		SHE (mm)	
Shank Dia.	Adjustment Range	Shank Dia.	Adjustment Range
Ø0.750"	+0.016 ~ -0.008	Ø20	+0.4 ~ -0.2
Ø1.000"		Ø25	
Ø1.250"		Ø32	
-	-	Ø40	+0.6 ~ -0.2

### 2 Center Height Adjustment ~ For Lathe Operations ~

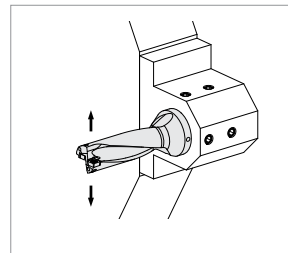

#### • Center Height Adjustment

ASL (in)		SHE (mm)	
Shank Dia.	Adjustment Range	Shank Dia.	Adjustment Range
Ø0.750"	+0.008 ~ -0.006	Ø20	+0.2 ~ -0.15
Ø1.000"		Ø25	
Ø1.250"		Ø32	
-	-	Ø40	+0.3 ~ -0.2

## How to Use the Adjustable Sleeve

### 1 Hole Diameter Adjustment when Drilling

1. Align the scale at the flange periphery of the sleeve to the center of the coolant plug of the drill. (Fig.1)
2. When making the hole diameter bigger, rotate the sleeve in the (+) direction and to make it smaller, rotate the sleeve in the (-) direction.
3. When rotating the sleeve, insert the wrench supplied with the drill into the hole on the flange periphery to rotate the sleeve.
4. Using the bottom screw of the side-lock arbor, firmly tighten the drill directly through the sleeve's window.  
The upper screw should be tightened slightly so that the sleeve will not be damaged.

#### (Caution)

- Not for use with collet chuck type arbor.
- Check the actual cutting diameter after adjusting.

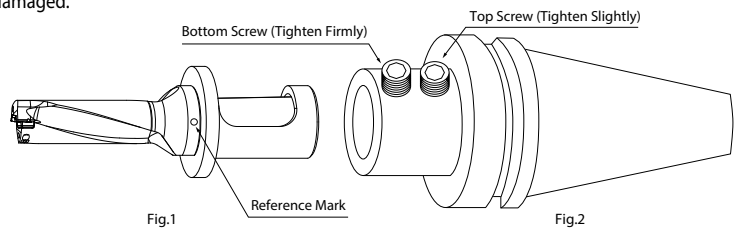

### 2 Center-Height Adjustment for Lathes

Most of the problems encountered with a turning lathe are center-height deviations.

The center height is appropriate if a core of about 0.5mm (0.020") diameter remains at the center of the hole.

Center-height adjustment is necessary when no core remains or if the core diameter is more than 1mm (0.039").

1. Align the drill with the outer insert face parallel to the X-axis of the tool turret. (Fig.4)
2. Align the scale (for the lathe) on the flange face of the sleeve to the center of the reference mark.
3. When no core remains, rotate the sleeve in the (+) direction to make the core larger, and when the core diameter is more than 1mm, rotate the sleeve in the (-) direction to make the core smaller.
4. When rotating the sleeve, insert the wrench supplied with the drill into the hole of the flange and then rotate the sleeve.
5. After Completing the adjustment, tighten the drill directly through the window on the sleeve.

#### (Caution)

Depending on amount of the center height adjustment, the hole diameter may change. It is recommended that the hole diameter is checked after the center height adjustment.

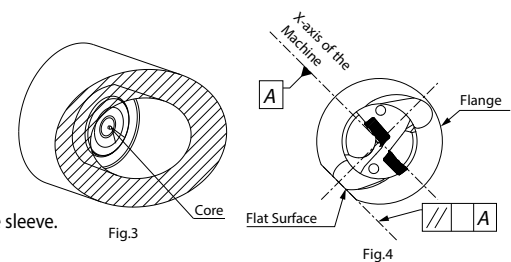

# Lathe Installation

1. The top face of the outer insert should be parallel to the X-axis to allow for offset cutting. (Cutting diameter can be changed by moving in the X-axis.)
2. It is recommended to set the outer insert as shown in Fig.1 with the outer insert facing the operator. (Fig.1)  
(It is also possible to use it by setting it in 180° reverse position)  
If the lathe has two turrets, when installing the drill into the lower turret, the outer insert should be set to face the operator.  
(It is also possible to use it by setting at 180° reverse position)

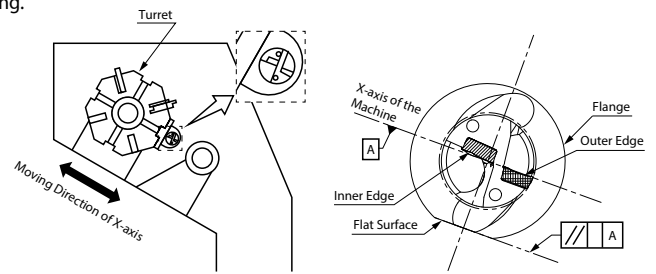

Fig.1 Installed into the Lathe

## Cutting Diameter Adjustment

### 1 Cutting Diameter Adjustment

1. Cutting diameter is adjusted by moving X-axis.  
The moving direction of the X-axis depends on the position of the toolholder.
2. For making the hole diameter larger, slide the tool along the X-axis toward the outer insert side. (Fig.2, Fig.3)  
For making the hole diameter smaller, slide the tool along the X-axis in the opposite direction.  
(This movement of the axis is called an "Offset")  
Be sure not to make the hole diameter smaller than the drill diameter by more than 0.2mm (0.008"). Otherwise, the toolholder will interfere with the drilled hole. (Fig.4)  
Ex.) When using  $\varnothing 20\text{mm}$  drill, the hole diameter must not be smaller than 19.8mm (0.780")

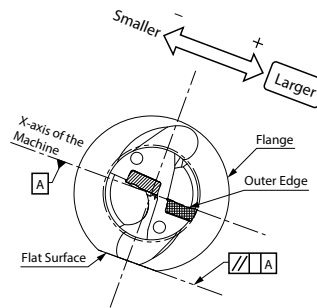

Fig.2 Outer Insert Facing Up

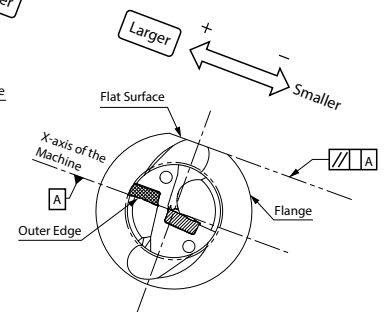

Fig.3 Outer Insert Facing Down

### 2 Offset Limit of the Cutting Diameter

- For the maximum limit of the cutting diameter, refer to "Max. Offset (Radial)" in the Toolholder Dimensions table.  
(The figure in the Toolholder Dimensions table shows how much it is possible to offset the drill in the radial direction.)  
Ex.) When using  $\varnothing 20\text{mm}$  ( $\varnothing 0.787''$ ) drill, for example, it is possible to make a hole up to  $\varnothing 21.1\text{mm}$  ( $0.831''$ ) since "Max. Offset (Radial)" is  $+0.55\text{mm}$  ( $+0.022''$ ).

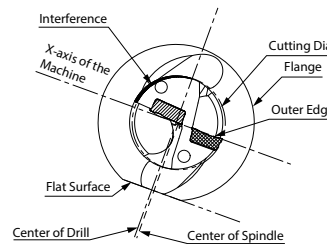

Fig.4 Excessive Offset (For Smaller Hole Diameter)

## Center Height Adjustment

### 1 Center Height of the Inner Insert

- When installing inner insert as shown in Fig.1, it will be set around 0.05mm (0.002") below the Center of Spindle. (Fig.5)  
This is the normal position of the center height.  
However, in case that the turret of the lathe is out of alignment with the Center of Spindle, sometimes the inner insert may be above or below center.  
For stable machining, it is essential to check the Center Height of the inner insert carefully

### 2 How to Check the Center Height

- For checking the center height of the inner insert, see the core which remains at the center of the bottom of the drilled hole.  
If the center height is in the normal position, a core of about 0.5mm (0.020") in diameter, will remain after machining. (Fig.6)  
Adjustment of center height is required if no core is present or a large core diameter of 1mm (0.039") or more remains.  
\* The drilled hole for verification purposes needs to be machined at approximately 10mm (0.375") in depth and at a feed rate of 0.004 ipr or lower.

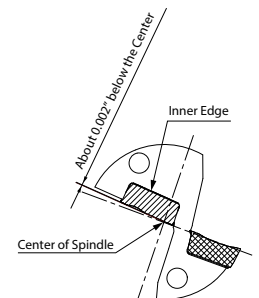

Fig.5 Front View of the Drill

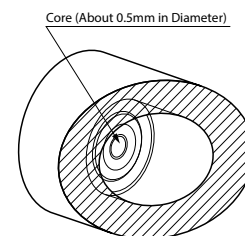

Fig.6 Center Core



### 3 Center Height Adjustment

#### 1. When there is no remaining core and the inner insert is chipping

This occurs when the inner insert is set above center. (Fig.7)

How to Adjust
<p>A. Install the drill rotated by 180° Most problems will be solved by this method (Fig.8)</p> <p>B. If the core diameter becomes too large after the above adjustment, install the drill by rotating 90° counter-clockwise as shown in Fig.9 (outer edge is positioned lower) and adjust the center height by moving the tool in the X-axis direction. (However, this will make it impossible to adjust the cutting diameter) Caution: When installing the drill in the opposite direction (outer insert is positioned above), the cutting diameter will become smaller, which may cause the drill body to interfere with the drilled hole. The best solution is to readjust the center position of the turret itself.</p>

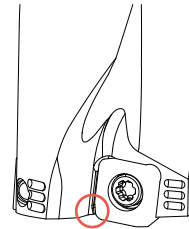

Fig.7 Insert breakage near the center of the drill

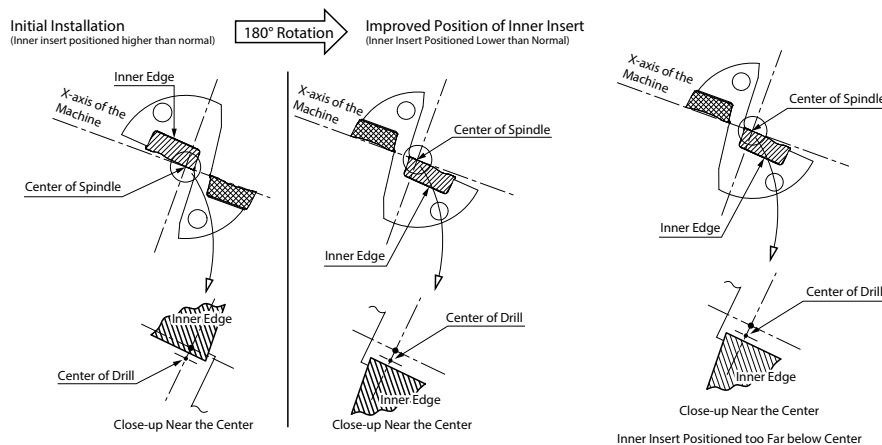

Fig.8

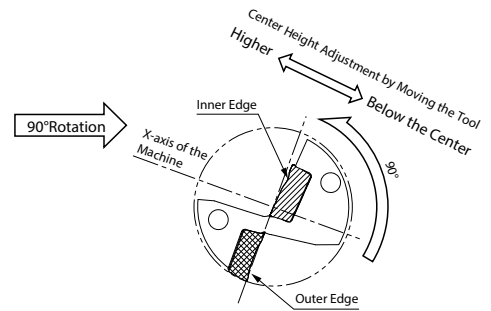

Fig.9

#### 2. Core with Excessively Large Diameter More than 1mm (0.039")

This occurs when the inner insert is below center  
This condition causes poor chip evacuation and an adjustment is required.

How to Adjust
<p>Install the drill rotated 90° as shown in Fig.10. (outer insert is positioned on the upper side) and adjust the center height by moving tool in the X-axis direction. (However, this will make it impossible to adjust the cutting diameter) Caution: When installing the drill in the opposite direction (outer insert is positioned lower), the cutting diameter will become smaller, which may cause the drill body to interfere with the drilled hole. The best solution is to readjust the center position of the turret itself.</p>

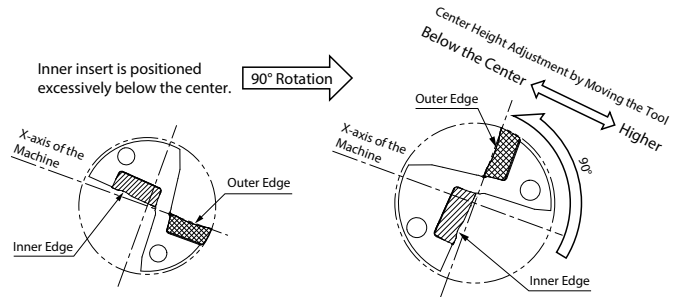

Fig.10



**KYOCERA Precision Tools**

102 Industrial Park Road  
Hendersonville, NC 28792  
Customer Service | 800.823.7284 - Option 1  
Technical Support | 800.823.7284 - Option 2



Official Website | [www.kyoceraprecisiontools.com](http://www.kyoceraprecisiontools.com)  
Distributor Website | [mykpti.kyocera.com](http://mykpti.kyocera.com)  
Email | [cuttingtools@kyocerapti.com](mailto:cuttingtools@kyocerapti.com)